



# NEVO600 SERIES



- Modular
- Configurable
- Patents pending

*600 watt in the palm of your hand*

The NEVO 600 is a modular and user configurable power supply offering unrivalled performance and flexibility. Delivering up to 600 watts from a 600 gram 5" x 3" x 1U package, the NEVO is the ultimate power solution for applications where size and weight are vital factors. Each system consists of an input module together with up to four isolated output modules. The series carry full UL60950 safety approvals and comply with EN61000-3, EN61000-4 and EN550022-B EMC standards.



## MAIN FEATURES:

- ✓ 600 watt output
- ✓ 5" x 3" x 1U footprint
- ✓ High power density (25W/in<sup>3</sup>)
- ✓ Industrial approvals
- ✓ High reliability
- ✓ High efficiency – up to 89%
- ✓ Only 0.6kg – 100W/kg
- ✓ I<sup>2</sup>C control option
- ✓ Remote current/voltage programming
- ✓ Accurate current sharing
- ✓ Current output signal
- ✓ 5V 200mA bias supply
- ✓ RoHS compliant
- ✓ Field configurable
- ✓ Two year warranty

## SYSTEM SPECIFICATIONS

INPUT ELECTRICAL						
Parameter	Details	Min	Typ	Max	Units	
AC Input Voltage	Nominal range is 100Vrms to 240Vrms	85		264	Vrms	
AC Input Frequency	Contact factory for 400Hz operation.	47	50/60	63	Hz	
DC Input Voltage	Standard	120		370	Vdc	
Power Rating	See graphs for deratings			600	Watts	
Input Current	600Watts output at 180Vrms input			4	Amps	
Inrush Current	265Vrms (cold start)			20	Amps	
Fusing	5x20 Fast acting			5	Amps	
Input Current Limit	Maintains power factor		6		Amps	
Efficiency	See graphs		86	89	%	
Idle Power	All outputs fitted and enabled		28		Watts	
Idle Power	All outputs fitted and Disabled		21		Watts	
Power Factor	Typical value for 300Watts output at 240Vrms input		0.96	0.99		
Holdup	600Watts output at 180Vrms input	17	20	21	mS	
UVLO	Turn on only	78		84	Vrms	
Over temperature	Internally monitored. Latching	115		125	°C	
Reliability	40°C 80% load			2	FPMH	
S i g n a l s	Bias Voltage	4.8	5	5.2	V	
	Bias current	0		200	mA	
	Power Good voltage	PNP open collector with internal 10k pull down resistor	8	10	15	V
	Power Good current		0		20	mA
	Inhibit voltage		2		15	V
	Inhibit current	10k ohm input impedance	0.2		1.5	mA
	Global inhibit voltage		3		15	V
	Global inhibit current	5k ohm input impedance	0.6		3	mA
	AC_OK voltage		1		4	V
	AC_OK current		-10		20	mA
AC_OK warning	See user manual for exceptions	5			mS	

INSTALLATION			
Parameter	Details	Parameter	Details
Equipment class	I	Flammability rating	94V-2
Installation category	II	IP Rating	IP10
Pollution degree	2	ROHS Compliance	2002/95/EC
Material group	IIIb (indoor use only)		

RELIABILITY				
Component	Details	Min	Max	Units
FAN	Mag Lev Std		3.8	FPMH
INPUT	Excluding FAN		2	FPMH
OUTPUT	See individual output datasheets		1	FPMH
Warranty			2	Years

SAFETY				
Parameter	Details	Min	Max	Units
Isolation Voltage	Input to Output		4000	Vac
	Input to Chassis		1500	Vac
	Output to Chassis		250	Vdc
	Output to Output		250	Vdc
Isolation Clearance	Primary to Secondary (Reinforced)	7		mm
	Primary to Chassis (Basic)	2.5		mm
Isolation Creepage	Primary to Secondary (Reinforced)	12		mm
	Primary to Chassis (Basic)	4		mm
Leakage Current	Standard: 265Vac, 63Hz, 25°C		1500	uA

MECHANICAL	
Parameter	Details
Size	77.7mm x 129.7mm x 41.0mm (all external dimensions ± 1.0mm)
Weight	360 gram +60 gram per output module
Mounting	Bottom or Side mounting (See diagram for details)



Patents pending

ENVIRONMENTAL						
	Parameter	Details	Min	Max	Units	
Storage	Temperature		-40	+85	°C	
	Humidity	Relative, non-condensing	5	95	%	
	Altitude		-200	5000	m	
	Air Pressure		54	106	kPa	
Operation	Temperature	Full power Derate input and outputs at 2.5%/°C	-20	50	°C	
	Humidity	Relative, non-condensing	5	95	%	
	Altitude	(-200 to 2000m for UL60601-1)	-200	3000	m	
	Air Pressure		78	106	kPa	
	Noise Level	Measured 1m from fan intake		45	dba	
	Shock	3000 bumps at 10G (16ms) half sine wave				
	Vibration	1.5G 10 to 200Hz sine wave, 20G for 15min in 3 axes random vibration				

EMC			
	Parameter	Standard	Level
Emissions	Radiated electric field	EN55011, EN55022, FCC	B
	Conducted emissions	EN55011, EN55022, FCC	B
	Harmonic Distortion	EN61000-3-2	Compliant
	Flicker & Fluctuation	EN61000-3-3	Compliant
Immunity	Electrostatic discharge	EN61000-4-2 (15kV air, 8kV contact)	4
	Radiated RFI	EN61000-4-3 (10V/m)	3
	Fast Transient burst	EN61000-4-4 (4kV)	4
	Input line surges	EN61000-4-5 (1kV L-N, 2kV L-E)	3
	Conducted RFI	EN61000-4-6 (10V)	4
	Power Freq. Magnetic Field	EN61000-4-8 (10A/m)	3
	Voltage Dips	EN61000-4-11 (EN55024)	Compliant

AGENCY APPROVALS			
Standard	Details	Standard	Details
IEC/EN60950-1			
UL60950-1			
CSA-C22.2 No. 60950-1-03			
CE MARK	LVD 73/23/EEC	UL file number	UL: E316486
CB certificate and report available on request			

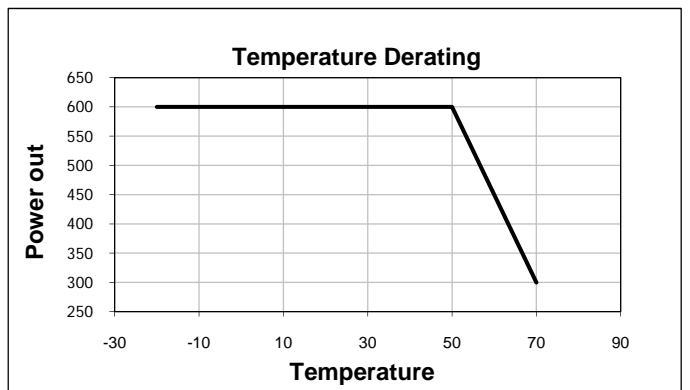
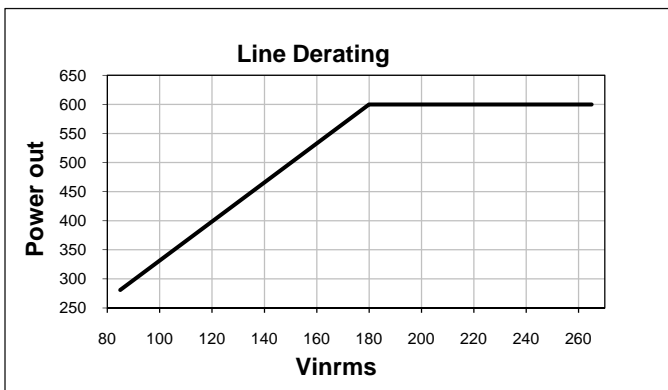
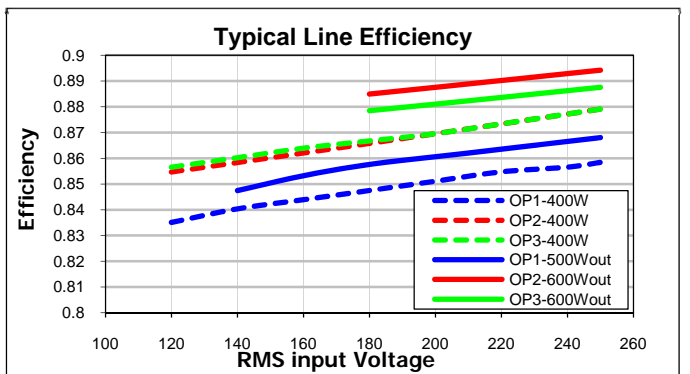
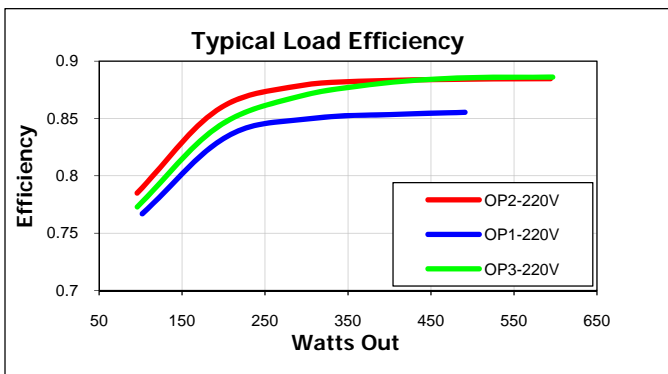
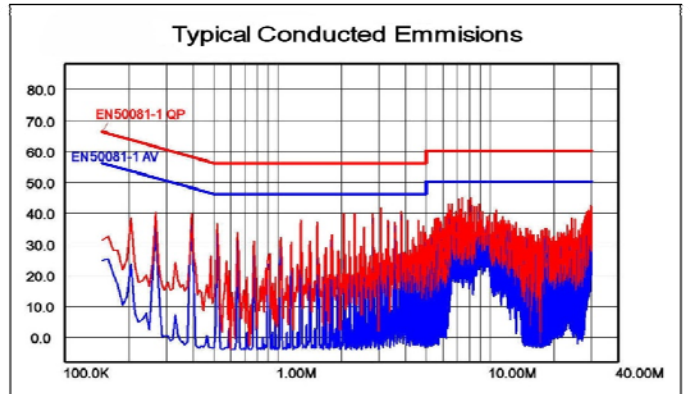

## MECHANICAL DIMENSIONS AND MOUNTING SCREWS

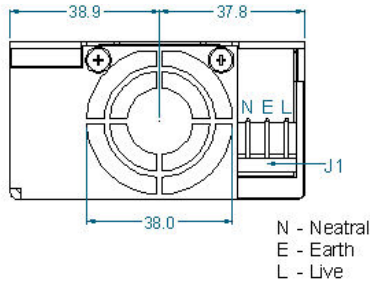

SCREWS	
MH1, MH2, MH3, MH4, MH5	
Screw type	M4
Tightening	Tighten to 1.5 Nm
Penetration depth	4.00mm max including chassis
OUTPUT MODULES x 8	
Screw type	M3x5, C/Sink, Posi, Stainless Steel
Tightening	Tighten to 0.75 Nm
Penetration depth	Defined by screw
CHASSIS x 5	
Screw type	M3x5, C/Sink, Posi, Stainless Steel
Tightening	Tighten to 0.75 Nm
Penetration depth	Defined by screw
FAN x 2	
Screw type	M3x24, C/Sink, Posi, Stainless Steel
Tightening	Tighten to 0.75 Nm
Penetration depth	Defined by screw

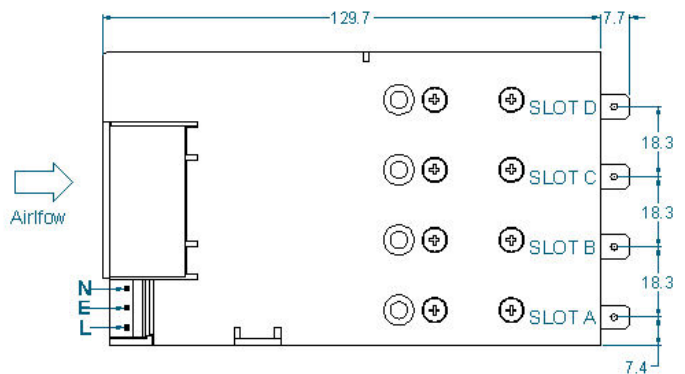
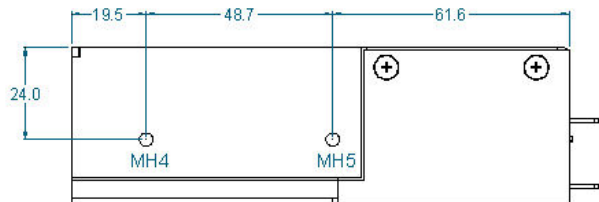
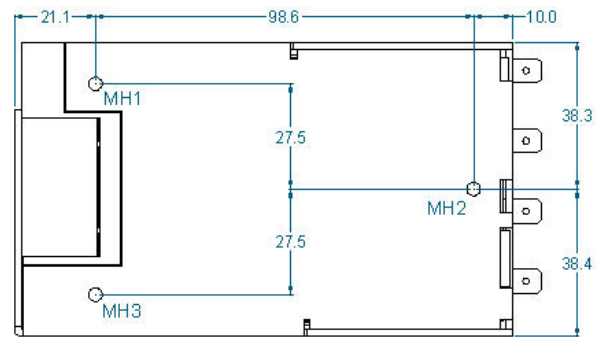
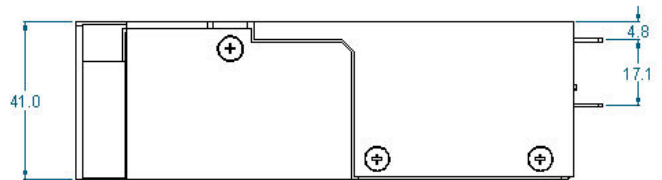

## CONNECTORS

PINOUTS	
J1	
Circuit	Details
1	Live
2	Earth
3	Neutral
J2	
Circuit	Details
1	Power Good
2	Inhibit
3	Power Good
4	Inhibit
5	Power Good
6	Inhibit
7	Power Good
8	Inhibit
9	Global Inhibit
10	AC OK
11	+5V 200mA Bias Supply
12	COM
J5	
Circuit	Details
1	-Sense
2	+Sense
3	Voltage Control
4	Current Control / Share / Out
5	COM
6	+5V local bias supply

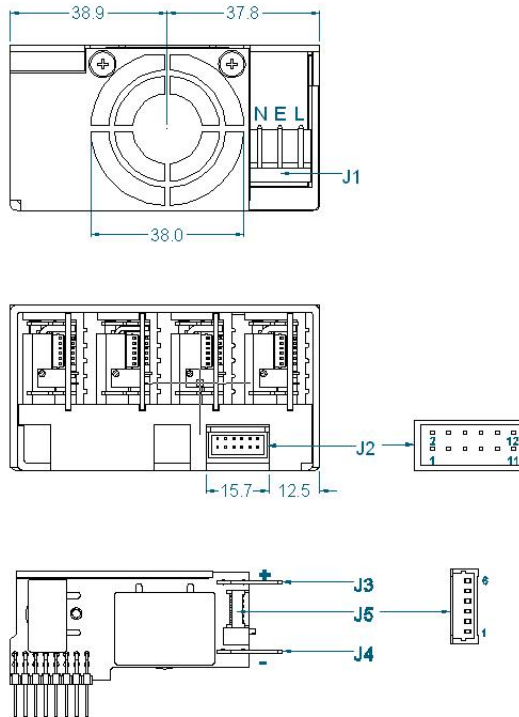

J3
Positive Output
J4
Negative Output

REF.	DETAILS	MANUFACTURER	TERMINAL
J1	MAINS INPUT: 3 Pin, 5.08mm, with Friction Lock, 18-24 AWG	MOLEX	8701031
J2	GLOBAL SIGNALS: 12 Pin, 2mm, with Friction Lock, 24-30 AWG	MOLEX	503948051
J2	IDT ALTERNATIVE FOR J2	MOLEX	N/A
J3/4(1)	OUTPUT POWER TERMINAL: TAB SIZE 6.35mmx0.8mm	VARIOUS	N/A
J5	OUTPUT SIGNALS: 6 Pin, 1.25mm, with Friction lock, 28-32 AWG	MOLEX	1510210600 50058800

**Notes**

- Terminal and Wire current rating must exceed maximum short circuit output current. Eg. Output 1 = 25A\*1.25 = 31.25Amps
- Direct equivalents may be used for any connector parts
- All cables must be rated 105°C min, equivalent to UL1015

## PART NUMBERING SYSTEM

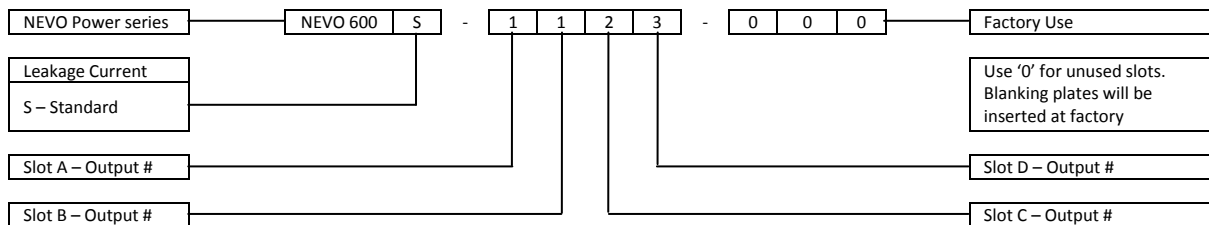

When initially ordering non-nominal voltage settings add "/Voltage" after each output # where a special voltage setting is required  
 E.g. If 3.30Vdc is required in slot B and all other slots require nominal voltages then use:

**NEVO 600S - 1 - 1/3.30 - 2 - 3**

The factory will then issue a 3 digit code for your specific configuration that can be used for all future orders of the same configuration  
 When ordering an input unit with no outputs inserted, simply order NEVO 600S

Vox Power Ltd. reserves the right to change or improve any part of the specification, electrical or mechanical design or manufacturing process without notice. Please consult your local distributor or contact Vox Power to ensure that you have the latest specification before using your product. For other information relating to the use of the product please refer to the latest NEVO user manual. Vox Power reserves the right to make changes without notice to any of its products. Vox Power does not assume any liability arising out of the use or application of any of its products and of any information to the maximum extent permitted by law. No license, express or implied, by estoppel or otherwise, to any intellectual property rights is granted by this document or by any conduct of Vox Power. VOX POWER DISCLAIMS ALL WARRANTIES AND REPRESENTATIONS. IN PARTICULAR ALL OTHER WARRANTIES, CONDITION OR TERMS RELATING TO SUITABILITY, FITNESS FOR PURPOSE, MERCHANTABILITY OR CONDITION OF THE PRODUCTS AND WHETHER EXPRESS OR IMPLIED BY STATUTE OR COMMON LAW OR OTHERWISE ARE EXCLUDED.

Document DOC6001 rev 02