

NVE
NVE CORPORATION

NEW!
IL41050 CAN
Transceiver



IsoLoop[®] **Isolation** **Products**

Short-Form
Catalog

Digital Isolators and Transceivers

IL600 and IL600A Passive Input Isolators

The Opto AlternativeSM

The IL600 and IL600A-Series Isolators are the world's first and only monolithic digital isolators. Our award-winning passive input technology combines optocoupler flexibility with superior IsoLoop performance. The IL600-Series has CMOS outputs and the IL600A-Series has high-voltage open-drain outputs.

The devices are manufactured with NVE's patented IsoLoop spintronic Giant Magnetoresistive (GMR) technology for small size, high speed, and low power, and are available in die form. Unlike other isolators, the IL600 and IL600A-Series can be configured for inverting or non-inverting inputs.

The IL600 and IL600A-Series Isolators are available in PDIP, SOIC, and unique MSOP packages. Parts are also available as bare die for chip-on-board assembly. All NVE products are supplied RoHS compliant as standard.

Popular IL600/IL600A-Series applications include serial line receivers, isolated I²C, and wired-OR controls.

Features:

- 2,500 V_{RMS} isolation (1 minute)
- Failsafe operation
- DC correct
- 5 mA input current
- 3.3 V or 5 V supply
- 2.5 mA dynamic input current (50% duty cycle)
- UL1577 and IEC61010 approval
- PDIP, SOIC, MSOP, or bare die

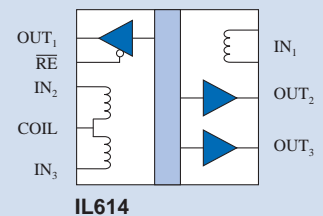
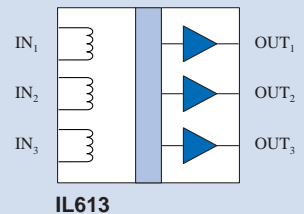
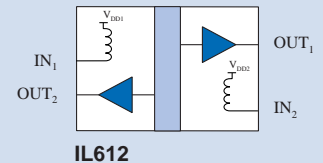
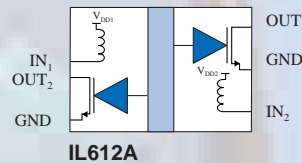
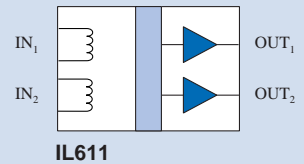
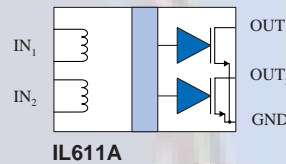
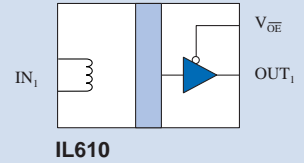
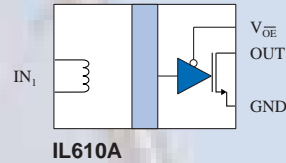

Parameter	Min.	Typ.	Max.	Units
Data Rate (A-Series)	100 (10)			Mbps
Pulse Width Distortion		3	5	ns
Propagation Delay		8	15	ns
Propagation Delay Skew		4	6	ns
Transient Immunity	15	20		kV/μs
Temperature Range	-40		+85	°C

IL500 Series Digital Input Isolators

The Cost-Effective Alternative

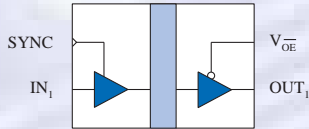

IL510

IL500-Series Isolators are the cost-effective, drop-in alternative to optocouplers. One, two, three, or four channel configurations; SOIC or unique MSOP packages. Some models feature a unique external clocking option, and the internal clock can be turned off for extremely low EMC. 2,500 V_{RMS} isolation; with UL1577 and IEC61010-2001 approval.

Popular IL500-Series applications include isolated A/D and D/A converters, serial interfaces, isolated SPI, and power interfaces.

Features:

- 2 Mbps
- 10 ns PWD
- DC correct
- 2,500 V_{RMS} isolation (1 minute)
- External clocking option (IL510 and IL515)
- MSOP and SOIC packages

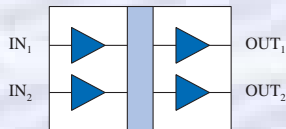

IL511

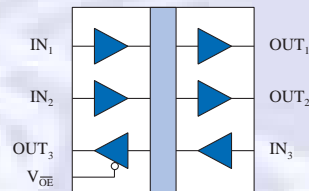

IL514

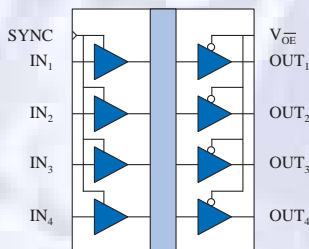

IL515

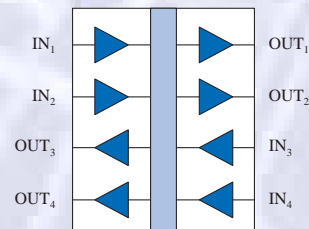

IL516

Parameter	Min.	Typ.	Max.	Units
Data Rate	2			Mbps
Pulse Width Distortion			10	ns
Propagation Delay			25	ns
Propagation Delay Skew			10	ns
Transient Immunity	20	30		kV/μs
Temperature Range	-40		+85	°C

IL700 and IL200 Series

The Ultimate in Speed and Performance

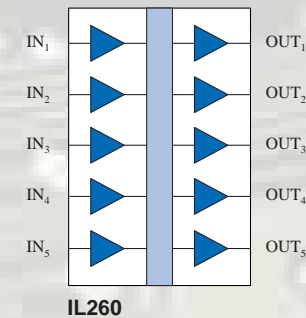
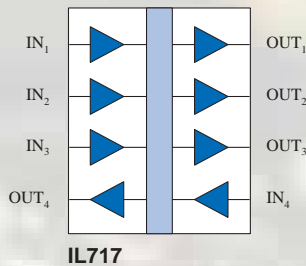
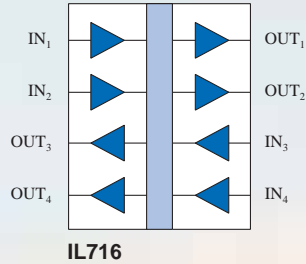
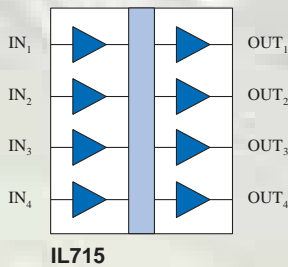
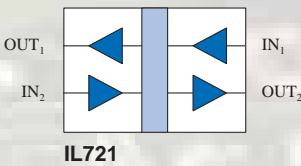
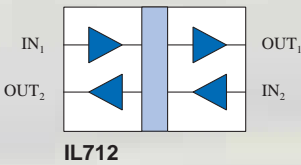
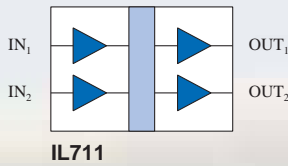
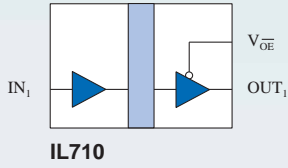

The IL700 and IL200-Series Digital Isolators provide unsurpassed performance and flexibility, including highest data rates, smallest packages, lowest distortion, low power consumption, widest temperature range, and 2,500 V_{RMS} isolation. All devices are UL1577 and IEC61010 approved.

Popular IL700/IL200 applications include serial interfaces, isolated CANbus, isolated SPI, isolated A/D converters, and power interfaces.

Features:

- **IL200 Series**
Five channels per package
- **IL700 Series**
World's smallest isolators (available MSOP)
- **IL700S Series**
Fastest (150 Mbps) and lowest PWD (300 ps)
- **IL700T Series**
Highest operating temperature (125°C with no derating)

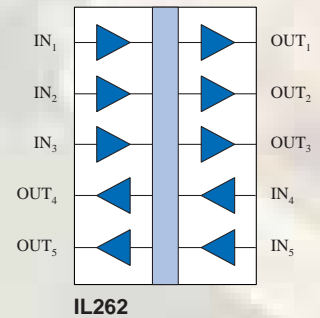
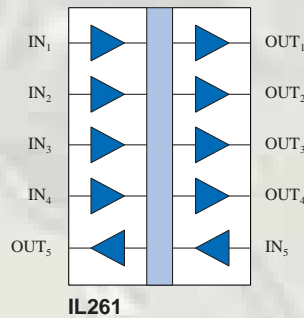

Parameters	Min.	Typ.	Max.	Units
Data Rate (S-Series)	100 (130)	110 (150)		Mbps
PWD (S-Series)		3 (0.3)	3	ns
Propagation Delay		10	15	ns
Propagation Delay Skew		4	6	ns
Transient Immunity	20	30		kV/μs
Temperature Range (T-Series)	-40		+100 (+125)	°C
IL200 Series	-40		+85	°C

IL400 and IL3000 Series Isolated Network Transceivers

NVE offers the widest choice of isolated RS-422, RS-485 and CAN network transceivers. Models provide very high speed, 15 kV ESD protection, handshake channels, and fractional loads. Versions are available in 0.15-inch and 0.3-inch SOIC packages, making these the most compact solutions in the world while still meeting the creepage and clearance requirements of applicable safety standards. All transceivers have an isolation rating of $2,500 V_{RMS}$ (one minute), and are supplied RoHS compliant as standard. All are UL1577 and IEC61010 approved; the IL41050 is ISO 11898 compliant; and the IL3685 is PROFIBUS compliant.

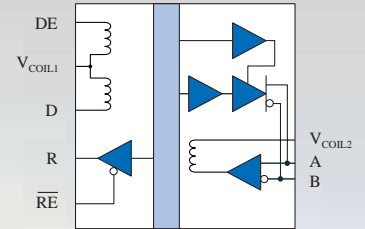

**IL3122/IL3185/
IL3222/IL3285/
IL3422/IL3485**

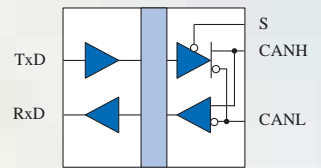

IL41050

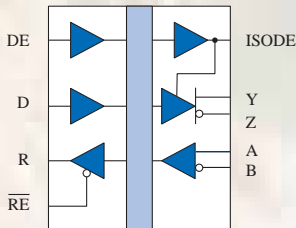

IL422/IL485

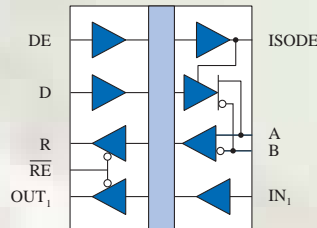

IL485W

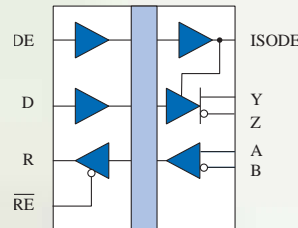

IL3522/IL3585

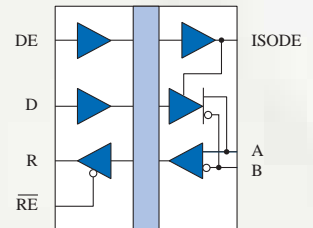

IL3685

Model Number	Bus	Data Rate (Mbps)	Nodes	Bus ESD (kV)	Key Features	Packages
IL3122	RS-422	5	32	15	Low Cost	0.15" SOIC-16; 0.3" SOIC-16
IL3185	RS-485	5	32	15	Low Cost	0.15" SOIC-16; 0.3" SOIC-16
IL3222	RS-422	5	256	15	Fractional Load	0.15" SOIC-16; 0.3" SOIC-16
IL3285	RS-485	5	256	15	Fractional Load	0.15" SOIC-16; 0.3" SOIC-16
IL3422	RS-422	20	32	15	High Speed	0.15" SOIC-16; 0.3" SOIC-16
IL3485	RS-485	20	32	15	High Speed	0.15" SOIC-16; 0.3" SOIC-16
IL422	RS-422	25	32	15	Industry Standard	0.3" SOIC-16
IL485	RS-485	35	32	2	Industry Standard	0.3" SOIC-16
IL485W	RS-485	35	32	2	RS-485 + handshake	0.3" SOIC-16
IL41050	CAN	1	110	4	ISO 11898 compliant	0.3" SOIC-16
IL3522	RS-422	40	50	15	Very High Speed	0.3" SOIC-16
IL3585	RS-485	40	50	15	Very High Speed	0.3" SOIC-16
IL3685	RS-485	40	50	15	PROFIBUS compliant	0.3" SOIC-16

Isolated Serial Interfaces

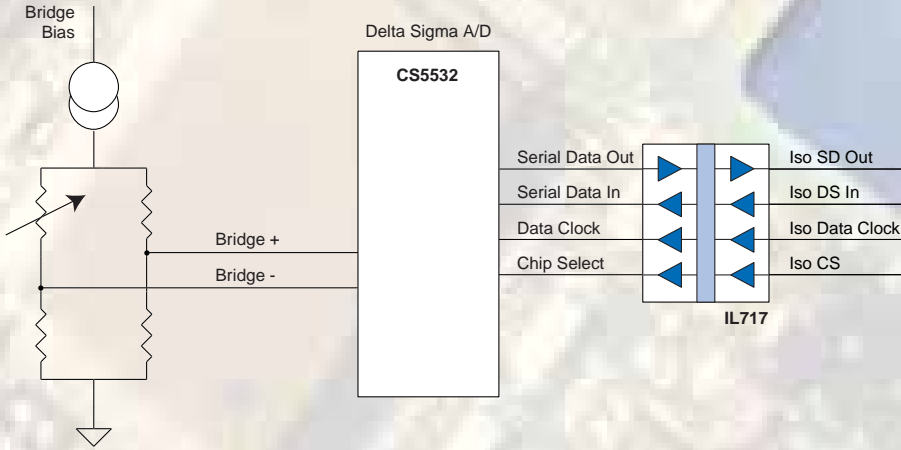

Isolated SPI Delta-Sigma A/D Converter Using IL717

This circuit illustrates a typical single-channel delta-sigma ADC isolated SPI interface. The ADC is located on the bridge with no signal conditioning electronics between the bridge sensor and the ADC. A five-channel IL261 can be used in a similar circuit that also distributes an isolated SPI clock to multiple ADCs.

Isolated I²C Using IL612A

This circuit provides bidirectional isolation of I²C bus signals with no restrictions on data rate, and none of the I²C bus latch-up problems common with other isolation circuits. The P82B96 buffer prevents loop latch-up in the low state by driving an I²C low voltage of 0.6 V on pin 3, preventing it from holding SDA low when SDA_Iso transitions from low to high.

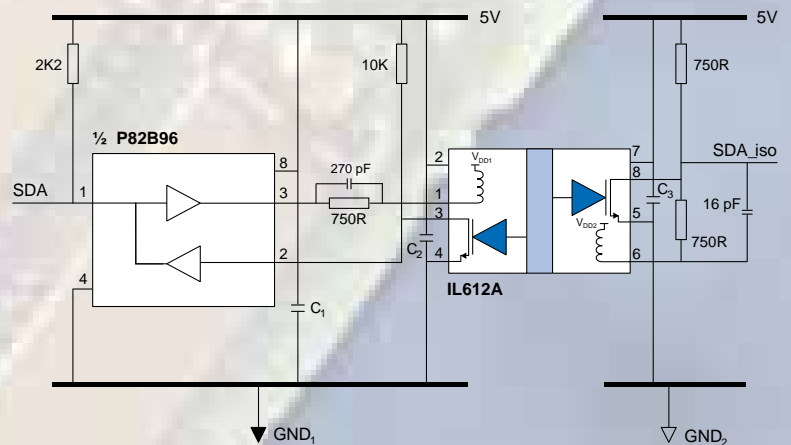

Notes:
C1, C2, and C3 are 47nF ceramic
Resistor values change for 3 V operation

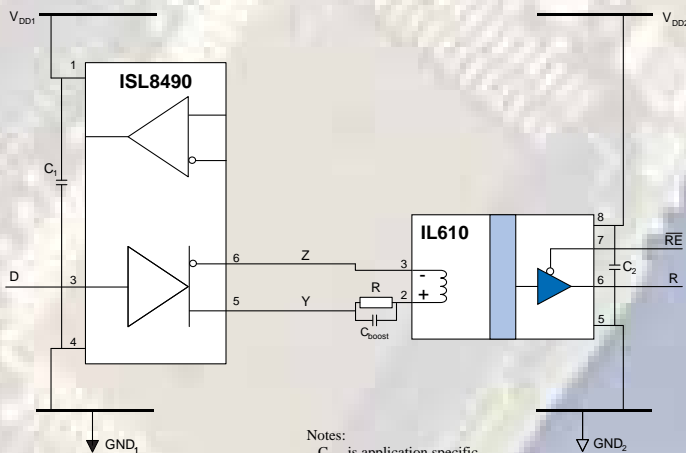

Notes:
C_{boost} is application specific
All other capacitors are 47 nF ceramic

RS-422 Receiver Using IL610

An IL610 can be used as a simple isolated RS-422 receiver. Cabling is greatly simplified by eliminating the need to power the input side of the receiving board. A similar circuit can be used for RS-485 networks. The IL610 provides 2,500 V_{RMS} isolation (one minute), and 20 kV/μs transient immunity. The IL610-1 is a unique MSOP isolator for space-critical boards.

Isolated Power Interfaces

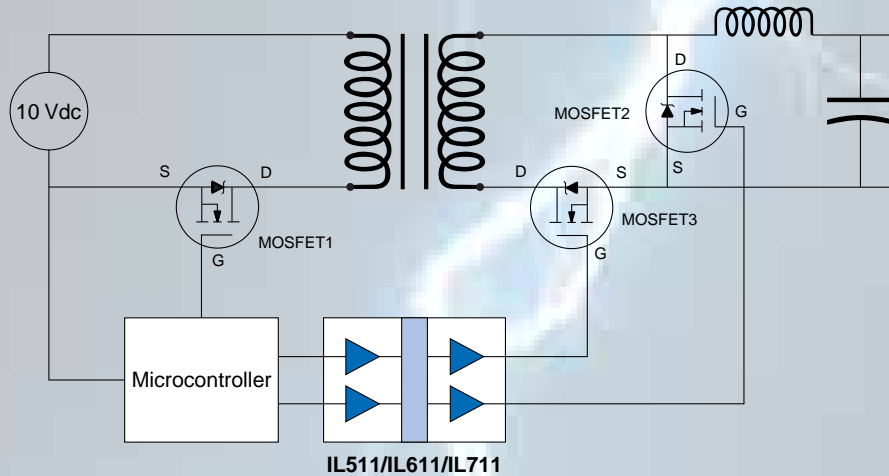

Intelligent DC-DC Converter With Synchronous Rectification

A typical primary-side controller would use an IL511, IL611 or IL711 to drive the synchronous rectification signals from primary side to secondary side. Isolator pulse-width distortion as low as 0.3 ns typical minimizes MOSFET dead time and maximizes system efficiency. Ultra-small isolator packages (including two-channel MSOP-8s), allow the designer to squeeze more into less board area.

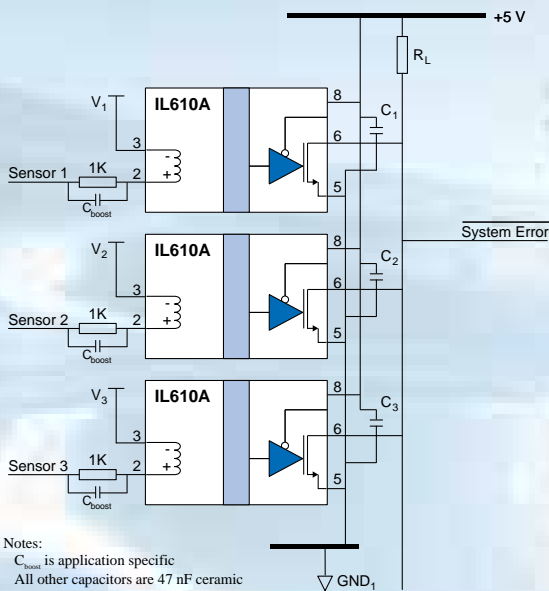

Multi-channel Isolated Alarm Monitor Using IL610As

IL600A Isolators' open-drain outputs can be wire-OR connected. Inputs can be configured for inverting or non-inverting operation, and a very wide input voltage range is possible. This illustrative circuit provides fail-safe output (logic high output for zero coil current), 2,500 V_{RMS} isolation, and 20 kV/ μ s transient immunity. Typical logic output sink current is 10 mA for each isolator.



About NVE

An ISO 9001 Certified Company

NVE Corporation manufactures innovative products based on unique spintronic Giant Magnetoresistive (GMR) technology. Products include Magnetic Field Sensors, Magnetic Field Gradient Sensors (Gradiometers), Digital Magnetic Field Sensors, Digital Signal Isolators, and Isolated Bus Transceivers.

NVE pioneered spintronics and in 1994 introduced the world's first products using GMR material, a line of ultra-precise magnetic sensors for position, magnetic media, gear speed and current sensing.

NVE Corporation
11409 Valley View Road
Eden Prairie, MN 55344-3617 USA
Telephone: (952) 829-9217
Fax: (952) 829-9189
Internet: www.nve.com
e-mail: iso-info@nve.com

Worldwide Distribution

NVE has a worldwide network of expert distributors ready to assist you. Visit the "Isolator Sales" section of www.nve.com for the nearest distributor.

The information provided by NVE Corporation is believed to be accurate. However, no responsibility is assumed by NVE Corporation for its use, nor for any infringement of patents, nor rights or licenses granted to third parties, which may result from its use. No license is granted by implication, or otherwise, under any patent or patent rights of NVE Corporation. NVE Corporation does not authorize, nor warrant, any NVE Corporation product for use in life support devices or systems or other critical applications, without the express written approval of the President of NVE Corporation.

Specifications are subject to change without notice.

On the Cover

IsoLoop Isolation Products help make a digital world practical. Approximately 750 actual-size IsoLoop MSOP Isolators form the image on the front and back spine of this catalog. NVE is the leader in MSOP isolators with a full line of part types and configurations.