

■ Features

- World's lowest power programmable oscillator, <3.5 mA typical current consumption
- 1-80 MHz frequency range. Contact SiTime for frequencies between 80 MHz - 110 MHz
- Extremely fast start-up time (<3 ms), enabling power-cycling for lower system power
- Available in four industry standard packages: 2.5 x 2.0, 3.2 x 2.5, 5.0 x 3.2, 7.0 x 5.0 mm
- Programmable standby or output enable modes
- <10 μ A current consumption in standby mode
- All-silicon device with outstanding reliability of 2 FIT, 10x improvement over quartz-based devices, enhancing system MTBF
- Outstanding mechanical robustness for portable applications
- Ultra short lead time
- Ideal for portable applications :portable media players, digital cameras, digital camcorders, portable navigation device, handheld gaming, cell phone and other handheld applications.
- Ideal for high-speed serial protocols such as: USB 1.1, USB 2.0, SATA, SAS, Fiber Channel, Firewire, Ethernet, PCI Express, etc



■ Specifications

Parameter	Symbol	Min.	Typ.	Max.	Unit	Condition
Output Frequency Range	f	1	-	80	MHz	Contact SiTime for frequencies between 80 MHz - 110 MHz
Frequency Tolerance	F _{tol}	-25	-	+25	PPM	Inclusive of: Initial tolerance, operating temperature, rated power, supply voltage change, load change, aging (1st yr@25°C), shock and vibration.
		-30	-	+30	PPM	
		-50	-	+50	PPM	
		-100	-	+100	PPM	
Aging	Ag	-	-	1.0	PPM	1st year at 25°C
Storage Temperature Range		-55	-	+125	°C	
Operating Temperature Range	T _{use}	-20	-	+70	°C	Extended Commercial
		-40	-	+85	°C	Industrial
Supply Voltage	V _{dd}	1.62	1.8	1.98	V	
		2.25	2.5	2.75	V	
		2.52	2.8	3.08	V	
		2.97	3.3	3.63	V	
Current Consumption	I _{dd}		3.0	3.5	mA	No load condition, f = 20 MHz, V _{dd} = 1.8 V
			3.5	4.0	mA	No load condition, f = 20 MHz, V _{dd} = 2.5 V, 2.8 V or 3.3 V
Standby Current	I _{std}	-	3	10	μ A	Output is Weakly Pulled Down, \overline{ST} = GND, V _{dd} = 1.8 V
		-	7	10	μ A	Output is Weakly Pulled Down, \overline{ST} = GND, V _{dd} = 2.5 V, 2.8V or 3.3 V
Duty Cycle	DC	45	-	55	%	All V _{dds} . f \leq 70 MHz
		40	-	60	%	All V _{dds} . f > 70 MHz
Rise/Fall Time	T _r , T _f	-	1	2	ns	20% - 80% V _{dd} level, 15pf load
Output Voltage High	VOH	90	-	-	%V _{dd}	I _{OH} = -4 mA (V _{dd} = 3.3 V) I _{OH} = -3 mA (V _{dd} = 2.8 V and V _{dd} = 2.5 V) I _{OH} = -2 mA (V _{dd} = 1.8 V)
Output Voltage Low	VOL	-	-	10	%V _{dd}	I _{OL} = 4 mA (V _{dd} = 3.3 V) I _{OL} = 3 mA (V _{dd} = 2.8 V and V _{dd} = 2.5 V) I _{OL} = 2 mA (V _{dd} = 1.8 V)
Output Load	L _d	-	-	15	pF	Maximum frequency and supply voltage. Contact SiTime for higher load
Input Voltage High	VIH	70	-	-	%V _{dd}	Pin 1, OE or \overline{ST}
Input Voltage Low	VIL	-	-	30	%V _{dd}	Pin 1, OE or \overline{ST}
Input Current	I _{in}	-	-	10	μ A	
Start up Time	T _{osc}	-	-	3	ms	Measured from the time V _{dd} reaches its rated minimum value
RMS Period Jitter	T _{jitt}	-	-	6	ps	f = 48 MHz, V _{dd} = 1.8 V
		-	-	4	ps	f = 48 MHz, V _{dd} = 2.5 V, 2.8 V or 3.3 V
RMS Phase Jitter (random)	T _{phj}	-	1.60	-	ps	f = 62.5 MHz, Integration bandwidth = 1.875 MHz to 20 MHz
		-	1.00	-	ps	f = 75 MHz, Integration bandwidth = 900 kHz to 7.5 MHz

■ Dimensions, Pin Description and Land Pattern

Dimensions (Unit: mm)^[1]

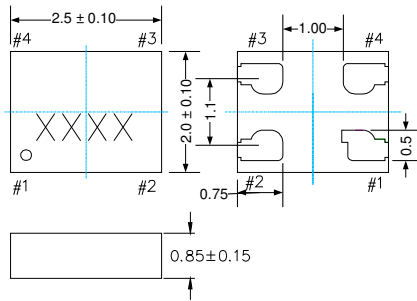

Pin #1 Functionality	
OE	
H or Open; specified frequency output	
L: output is high impedance	
ST	
H or Open; specified frequency output	
L: output is low level (weak pull down)	

Pin Map	
Pin	Connection
1	OE/ \overline{ST}
2	GND
3	CLK
4	VDD

Recommended Land Pattern (Unit: mm)^[2]

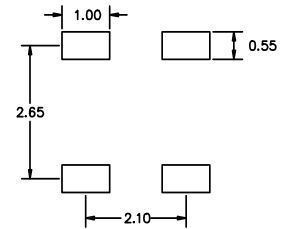

Dimensions (Unit: mm)^[1]

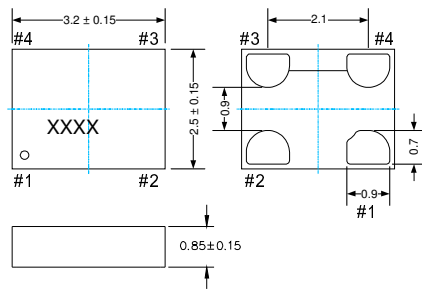

Pin #1 Functionality	
OE	
H or Open; specified frequency output	
L: output is high impedance	
\overline{ST}	
H or Open; specified frequency output	
L: output is low level (weak pull down)	

Pin Map	
Pin	Connection
1	OE/ \overline{ST}
2	GND
3	CLK
4	VDD

Recommended Land Pattern (Unit: mm)^[2]

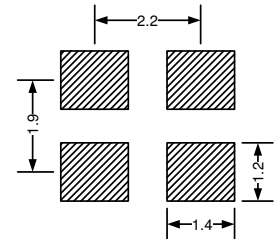

Dimensions (Unit: mm)^[1]

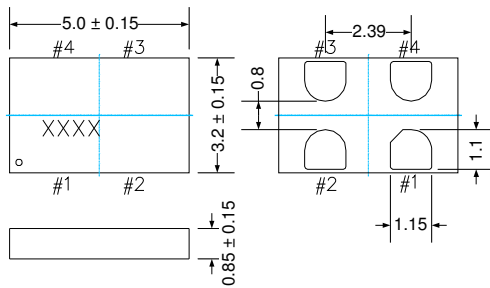

Pin #1 Functionality	
OE	
H or Open; specified frequency output	
L: output is high impedance	
\overline{ST}	
H or Open; specified frequency output	
L: output is low level (weak pull down)	

Pin Map	
Pin	Connection
1	OE/ \overline{ST}
2	GND
3	CLK
4	VDD

Recommended Land Pattern (Unit: mm)^[2]

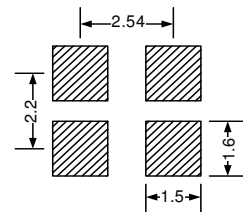

Dimensions (Unit: mm)^[1]

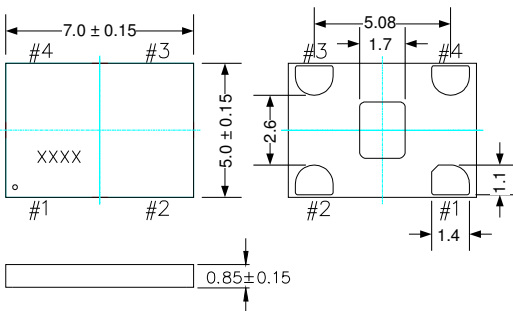

Pin #1 Functionality	
OE	
H or Open; specified frequency output	
L: output is high impedance	
\overline{ST}	
H or Open; specified frequency output	
L: output is low level (weak pull down)	

Pin Map	
Pin	Connection
1	OE/ \overline{ST}
2	GND
3	CLK
4	VDD

Recommended Land Pattern (Unit: mm)^[2]

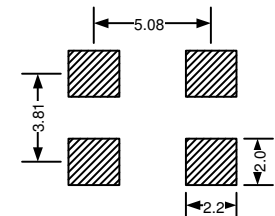

Notes:

- XXXX top marking denotes manufacturing lot number.
- A capacitor of value 0.1 μ F between Vdd and GND is recommended.

SiT8003AC-14-18E-123.12345T

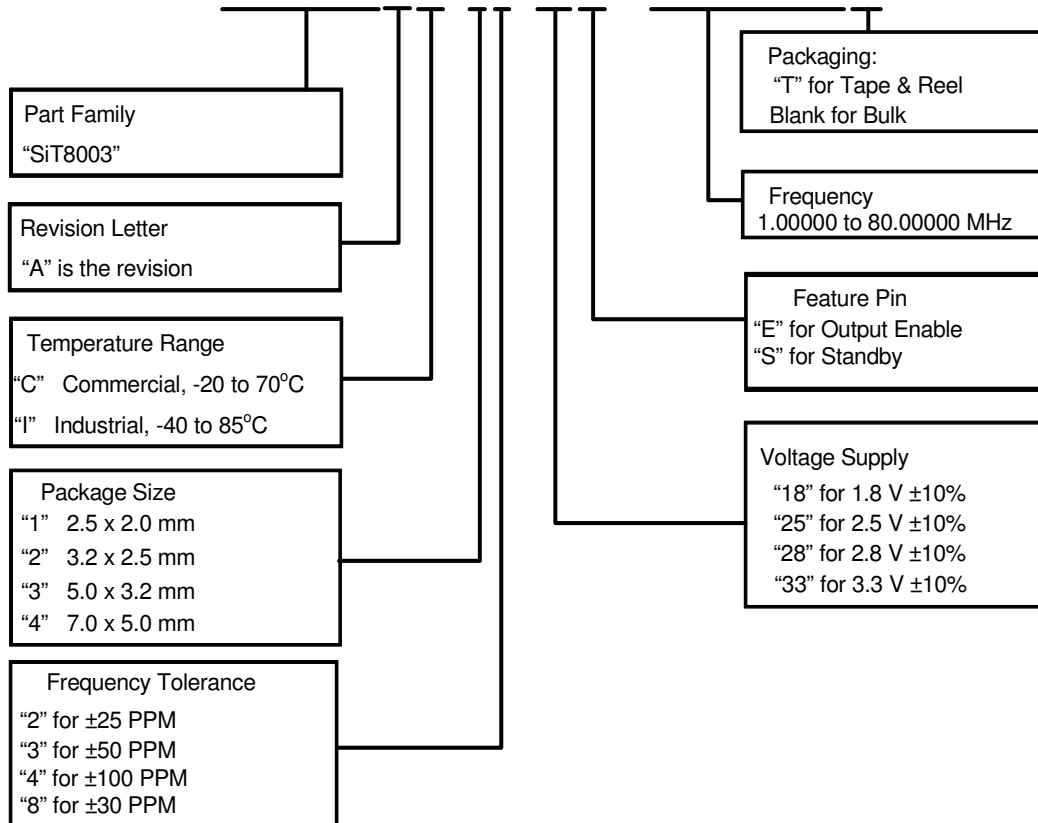

Alcom Belgium - Singel 3 - 2550 Kontich
 Tel.: ++32 (0)3 458.30.33 - Fax: ++32 (0)3 458.31.26 - info@alcom.be
 Alcom Netherlands - Rivium 1e straat 52 - 2909 LE Capelle a/d IJssel
 Tel.: ++31 (0)10 288.25.00 - Fax: ++31 (0)10 288.25.25 - info@alcom.nl

© SiTime Corporation 2009. The information contained herein is subject to change at any time without notice. SiTime assumes no responsibility or liability for any loss, damage or defect of a Product which is caused in whole or in part by (i) use of any circuitry other than circuitry embodied in a SiTime product, (ii) misuse or abuse including static discharge, neglect or accident, (iii) unauthorized modification or repairs which have been soldered or altered during assembly and are not capable of being tested by SiTime under its normal test conditions, or (iv) improper installation, storage, handling, warehousing or transportation, or (v) being subjected to unusual physical, thermal, or electrical stress.

Disclaimer: SiTime makes no warranty of any kind, express or implied, with regard to this material, and specifically disclaims any and all express or implied warranties, either in fact or by operation of law, statutory or otherwise, including the implied warranties of merchantability and fitness for use or a particular purpose, and any implied warranty arising from course of dealing or usage of trade, as well as any common-law duties relating to accuracy or lack of negligence, with respect to this material, any SiTime product and any product documentation. Products sold by SiTime are not suitable or intended to be used in a life support application or component, to operate nuclear facilities, or in other mission critical applications where human life may be involved or at stake. All sales are made conditioned upon compliance with the critical uses policy set forth below.

CRITICAL USE EXCLUSION POLICY
 BUYER AGREES NOT TO USE SITIME'S PRODUCTS FOR ANY APPLICATION OR IN ANY COMPONENTS USED IN LIFE SUPPORT DEVICES OR TO OPERATE NUCLEAR FACILITIES OR FOR USE IN OTHER MISSION-CRITICAL APPLICATIONS OR COMPONENTS WHERE HUMAN LIFE OR PROPERTY MAY BE AT STAKE.

SiTime owns all rights, title and interest to the intellectual property related to SiTime's products, including any software, firmware, copyright, patent, or trademark. The sale of SiTime products does not convey or imply any license under patent or other rights. SiTime retains the copyright and trademark rights in all documents, catalogs and plans supplied pursuant to or ancillary to the sale of products or services by SiTime. Unless otherwise agreed to in writing by SiTime, any reproduction, modification, translation, compilation, or representation of this material shall be strictly prohibited.