

C_L Capacitor-Less 500mA Low Power Consumption High Speed LDO Regulator

GENERAL DESCRIPTION

The XC6503 series is a 500mA high speed CMOS LDO regulator that can provide stable output voltages even without a load capacitor C_L. The devices are available in fixed output voltage from 1.2V to 5.0V in 0.05V increments

The C_L capacitor-less is possible because phase compensation is carried out internally unlike other LDOs where it is done externally. It results in saving board design space. The current limit fold-back circuit and thermal shutdown circuit work as protection circuit. The XC6503P is a 3-Terminal regulator and the XC6503D has a chip enable function, which enables the entire circuit to be turned off by a low level input signal to the CE pin.

When a C_L capacitor is used, the IC can discharge the electric charge stored at the output capacitor through the internal switch while in standby state, and as a result the V_{OUT} quickly returns to the V_{SS} level.

APPLICATIONS

- Mobile phones
- Portable game consoles
- Digital still camera modules
- Wireless LAN modules
- Liquid crystal display modules
- Bluetooth modules
- Digital TV tuner modules

FEATURES

Maximum Output Current	: 500mA
Input Voltage Range	: 1.7V ~ 6.0V
Output Voltage Range	: 1.2V ~ 5.0V (0.05V increments)
Output Accuracy	: ±1.0% (2.0V~5.0V) ±20mV (1.2V~1.95V)
Temperature Stability	: ±30ppm/°C
Dropout Voltage	: 190mV@V _{OUT} =2.8V, I _{OUT} =300mA
Low Power Consumption	: 15 μA (TYP.), 0.1 μA (in standby)
High PSRR	: 55dB@1kHz, V _{OUT} =2.8V
Protection Current	: Current Limiter (630mA TYP.) Short-circuit Protection Thermal Shutdown
C _L Capacitor-Less	: Internal Phase Compensation
Operating Temperature Range	: -40°C~+85°C
Packages	: USP-4 (*), SOT-25, SOT-89-5 (XC6503D) TO-252 (XC6503P *) *Under Development
Environmentally Friendly	: EU RoHS Compliant, Pb Free

TYPICAL APPLICATION CIRCUIT

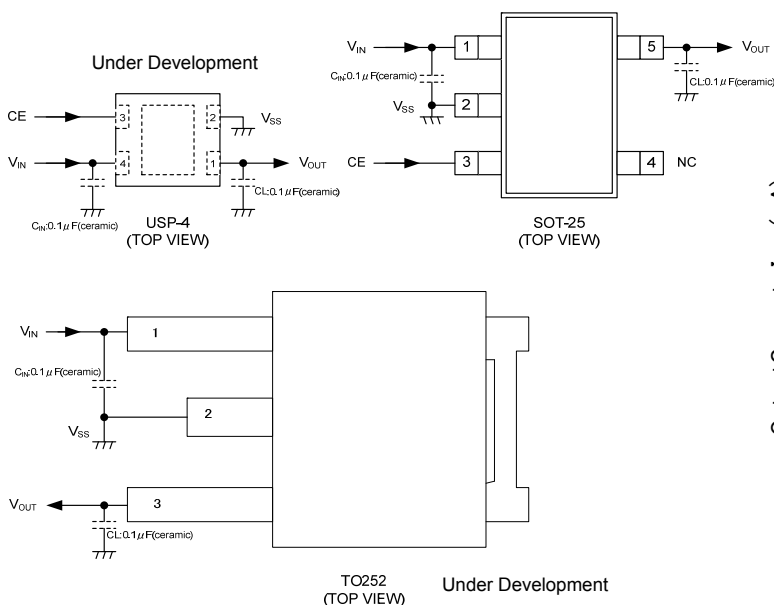

TYPICAL PERFORMANCE CHARACTERISTICS

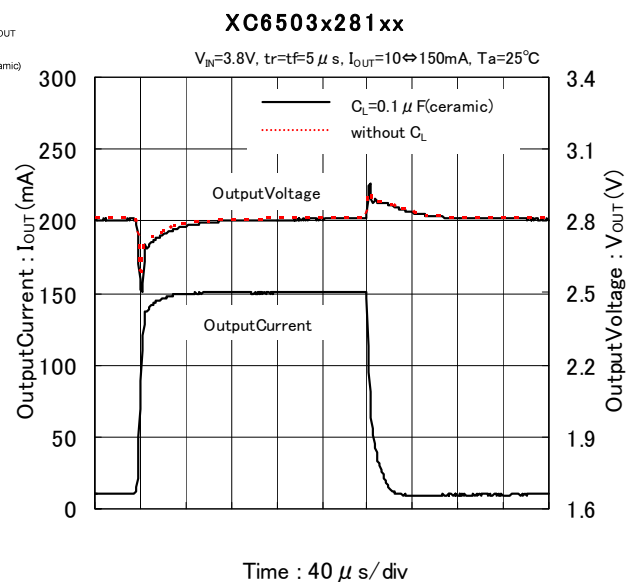

PIN CONFIGURATION

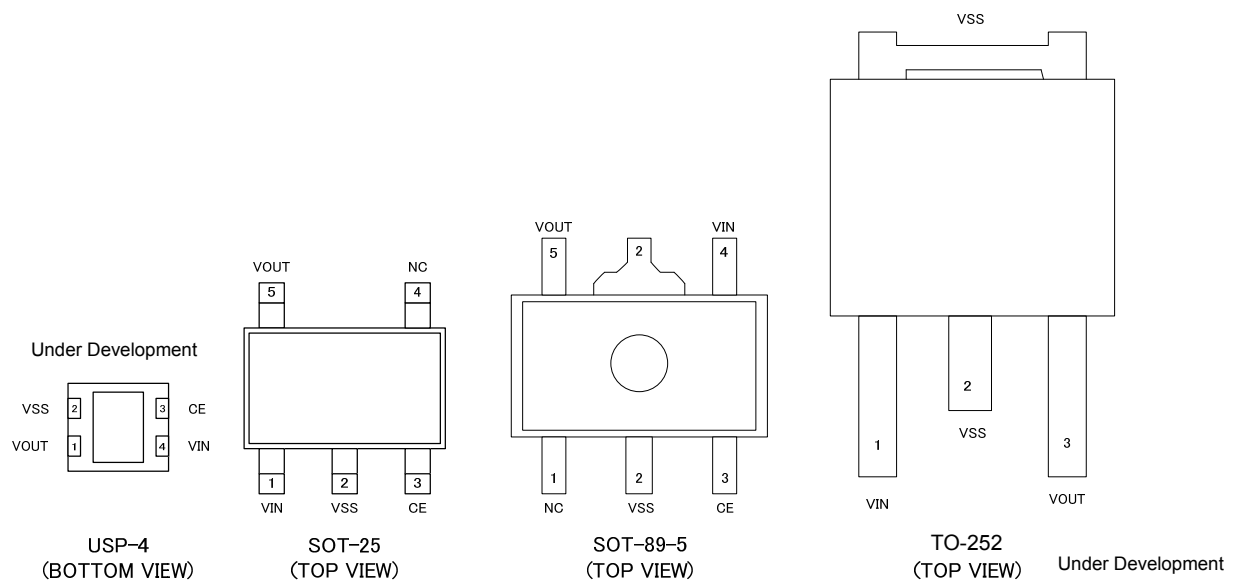

*The dissipation pad for the USP-4 package should be solder-plated in recommended mount pattern and metal masking so as to enhance mounting strength and heat release. If the pad needs to be connected to other pins, it should be connected to the V_{SS} (No. 2) pin.

PIN ASSIGNMENT

PIN NUMBER				PIN NAME	FUNCTIONS
USP-4	SOT-25	SOT89-5	TO-252		
4	1	4	1	V_{IN}	Power Input
1	5	5	3	V_{OUT}	Output
2	2	2	2	V_{SS}	Ground
3	3	3	-	CE	ON/OFF Control
-	4	1	-	NC	No Connection

* USP-4 and TO-252 are under development.

PRODUCT CLASSIFICATION

Ordering Information XC6503D with ON/OFF function

XC6503 - ^{(*)1}

DESIGNATOR	ITEM	SYMBOL	DESCRIPTION
①	Type of Regulator ^{(*)2}	D	CE Active High, with CE Pull-down, C _L discharge
②③	Output Voltage ^{(*)3}	12~50	ex.) ②=2, ③=8 → 2.8V
④	Output Accuracy	1	±0.02V (1.2~1.9V)、±1% (2.0~5.0V)
⑤⑥-⑦	Packages (Order Unit)	GR-G	USP-4 (3,000/Reel) (Under Development)
		MR-G	SOT-25 (3,000/Reel)
		PR-G	SOT-89-5 (1,000/Reel)

^{(*)1} The "-G" suffix indicates that the products are Halogen and Antimony free as well as being fully RoHS compliant.

^{(*)2} For without CE Pull-down or without CL discharge function, please contact your local Torex sales office or representative.

^{(*)3} For the output voltage in 0.05V increments, please contact your local Torex sales office or representative.

Ordering Information XC6503P 3-Terminal regulator * Under Development

XC6503 - ^{(*)1}

DESIGNATOR	ITEM	SYMBOL	DESCRIPTION
①	Type of Regulator	P	3-Terminal regulator, without CE pin
②③	Output Voltage ^{(*)2}	12~50	ex.) ②=2, ③=8 → 2.8V
④	Output Accuracy	1	±0.02V (1.2~1.9V)、±1% (2.0~5.0V)
⑤⑥-⑦	Packages (Order Unit)	JR-G	TO-252 (2,500/Reel)

^{(*)1} The "-G" suffix indicates that the products are Halogen and Antimony free as well as being fully RoHS compliant.

^{(*)2} For the output voltage in 0.05V increments, please contact your local Torex sales office or representative.

BLOCK DIAGRAMS

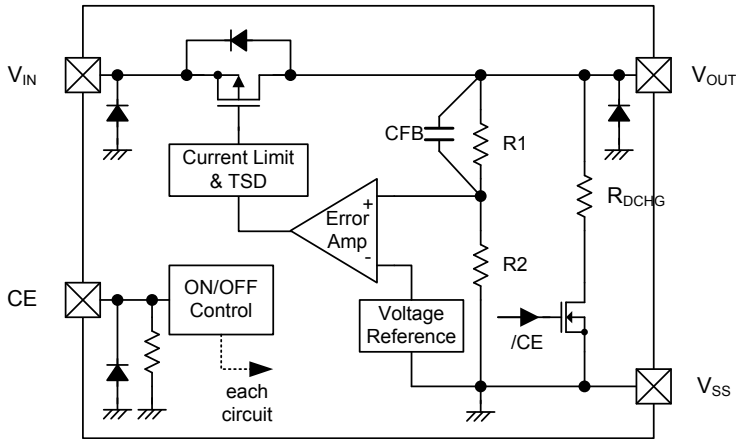

XC6503D Series

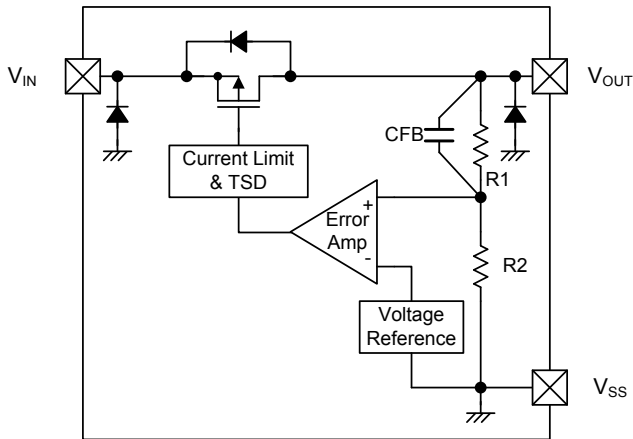

XC6503P Series Under Development

* Diodes inside the circuits are ESD protection diodes and parasitic diodes.

ABSOLUTE MAXIMUM RATINGS

Ta=25

PARAMETER	SYMBOL	RATINGS	UNITS
Input Voltage	V _{IN}	V _{SS} -0.3~+6.5	V
Output Current	I _{OUT}	850 ^(*)	mA
Output Voltage	V _{OUT}	V _{SS} -0.3~V _{IN} +0.3	V
CE Input Voltage	V _{CE}	V _{SS} -0.3~+6.5	V
Power Dissipation	USP-4 ^(**)	120	mW
	SOT-25	250	
	SOT-89-5	500	
	TO-252 ^(**)	500	
Power Dissipation ^(**) (PCB mounted)	USP-4 ^(**)	1000	mW
	SOT-25	600	
	SOT-89-5	1300	
	TO-252 ^(**)	1800	
Operating Temperature Range	T _{opr}	-40~+85	°C
Storage Temperature Range	T _{stg}	-55~+125	°C

(*) $Pd > (V_{IN} - V_{OUT}) \times I_{OUT}$

(**) The power dissipation measured with the test board condition is listed as reference data. Please refer to page 22 ~ 25 for details.

(**) USP-4 and TO-252 are under development.

ELECTRICAL CHARACTERISTICS

XC6503D Series

Ta=25°C

PARAMETER	SYMBOL	CONDITIONS	MIN.	TYP.	MAX.	UNITS	CIRCUITS
Output Voltage	V _{OUT(E)} ⁽²⁾	2.0V > V _{OUT(T)} ⁽³⁾ , V _{CE} =V _{IN} , I _{OUT} =10mA	-0.02 ⁽⁴⁾	V _{OUT(T)}	+0.02 ⁽⁴⁾	V	①
		2.0V ≤ V _{OUT(T)} , V _{CE} =V _{IN} , I _{OUT} =10mA	×0.99 ⁽⁴⁾		×1.01 ⁽⁴⁾		
Maximum Output Current	I _{OUTMAX}	V _{CE} =V _{IN}	500	-	-	mA	①
Load Regulation	ΔV _{OUT}	V _{CE} =V _{IN} , 0.1mA ≤ I _{OUT} ≤ 300mA	-	20	50	mV	①
Dropout Voltage ⁽⁵⁾	V _{dif}	V _{CE} =V _{IN} , I _{OUT} =250mA	E-1			mV	①
Supply Current	I _{DD}	V _{IN} =V _{CE} =6.0V, I _{OUT} =0mA	-	15	30	μA	②
Stand-by Current	I _{stby}	V _{IN} =6.0V, V _{CE} =V _{SS}	-	0.01	0.1	μA	②
Line Regulation	$\frac{\Delta V_{OUT}}{(\Delta V_{IN} \cdot V_{OUT})}$	V _{OUT(T)} +0.5V ≤ V _{IN} ≤ 6.0V, V _{CE} =V _{IN} , I _{OUT} =30mA	E-2			%/V	①
Input Voltage	V _{IN}		1.7	-	6.0	V	①
Output Voltage Temperature Characteristics	$\frac{\Delta V_{OUT}}{(\Delta T_a \cdot V_{OUT})}$	V _{CE} =V _{IN} , I _{OUT} =30mA -40°C ≤ Ta ≤ 85°C	-	±30	-	ppm/°C	①
Ripple Rejection Rate	PSRR	V _{OUT(T)} ≤ 4.75V V _{IN} = {V _{OUT(T)} + 1.0} V _{DC} + 0.5V _{p-pAC} V _{CE} =V _{IN} , I _{OUT} =30mA, f=1kHz	-	55	-	dB	③
		V _{OUT(T)} ≥ 4.80V V _{IN} = 5.75V _{DC} + 0.5V _{p-pAC} V _{CE} =V _{IN} , I _{OUT} =30mA, f=1kHz					
Current Limit	I _{LIM}	V _{CE} =V _{IN}	510	630	750	mA	①
Short-circuit Current	I _{SHORT}	V _{CE} =V _{IN} Short V _{OUT} to V _{SS} level	-	120	210	mA	①
CE High Level Voltage	V _{CEH}		1.0	-	6.0	V	①
CE Low Level Voltage	V _{CEL}		V _{SS}	-	0.3	V	①
CE High Level Current	I _{CEH}	V _{IN} =V _{CE} =6.0V	3.5	6	10	μA	①
CE Low Level Current	I _{CEL}	V _{CE} =V _{SS}	-0.1	-	0.1	μA	①
CL Discharge Resistance	R _{DCHG}	V _{IN} =6.0V, V _{OUT} =5.0V, V _{CE} =V _{SS}	300	430	500	Ω	①
Thermal Shutdown Detect Temperature	T _{TSD}	Junction Temperature	-	150	-	°C	①
Thermal Shutdown Release Temperature	T _{TSR}	Junction Temperature	-	125	-	°C	①
Thermal Shutdown Hysteresis Width	T _{HYS}	T _{TSD} -T _{TSR}	-	25	-	°C	-

NOTE:

(*1) Unless otherwise stated regarding input voltage conditions, V_{IN}=V_{OUT(T)}⁽³⁾+1.0V.

(*2) V_{OUT(E)}: Effective output voltage

(i.e. the output voltage when "V_{OUT(T)}+1.0V" is provided at the V_{IN} pin while maintaining a certain I_{OUT} value.)

(*3) V_{OUT(T)}: Nominal output voltage

(*4) Characteristics of the actual V_{OUT(E)} by setting output voltage is shown in the voltage chart.

(*5) V_{dif}=V_{IN1}⁽⁷⁾-V_{OUT1}⁽⁶⁾

(*6) V_{OUT1} is a voltage equal to 98% of the output voltage whenever an amply stabilized I_{OUT} {V_{OUT(T)}+1.0V} is input

(*7) V_{IN1} is an input voltage when V_{OUT1} appears at the V_{OUT} pin while the input voltage is gradually decreased.

ELECTRICAL CHARACTERISTICS (Continued)

XC6503P Series

Ta=25°C

PARAMETER	SYMBOL	CONDITIONS	MIN.	TYP.	MAX.	UNITS	CIRCUITS
Output Voltage	V _{OUT(E)} ⁽²⁾	2.0V > V _{OUT(T)} ⁽³⁾ , I _{OUT} =10mA	-0.02 ⁽⁴⁾	V _{OUT(T)}	+0.02 ⁽⁴⁾	V	①
		2.0V ≤ V _{OUT(T)} , I _{OUT} =10mA	×0.99 ⁽⁴⁾		×1.01 ⁽⁴⁾		
Maximum Output Current	I _{OUTMAX}		500	-	-	mA	①
Load Regulation	ΔV _{OUT}	0.1mA ≤ I _{OUT} ≤ 300mA	-	20	50	mV	①
Dropout Voltage ⁽⁵⁾	V _{dif}	I _{OUT} =250mA	E-1			mV	①
Supply Current	I _{DD}	V _{IN} =6.0V, I _{OUT} =0mA		15	30	μA	②
Line Regulation	$\frac{\Delta V_{OUT}}{(\Delta V_{IN} \cdot V_{OUT})}$	V _{OUT(T)} +0.5V ≤ V _{IN} ≤ 6.0V, I _{OUT} =30mA	E-2			%/V	①
Input Voltage	V _{IN}		1.7	-	6.0	V	①
Output Voltage Temperature Characteristics	$\frac{\Delta V_{OUT}}{(\Delta T_a \cdot V_{OUT})}$	I _{OUT} =30mA -40°C ≤ Ta ≤ 85°C	-	±30	-	ppm/°C	①
Ripple Rejection Rate	PSRR	V _{OUT(T)} ≤ 4.75V V _{IN} = [V _{OUT(T)} +1.0] V _{DC} +0.5Vp-p _{AC} I _{OUT} =30mA, f=1kHz	-	55	-	dB	③
		V _{OUT(T)} ≥ 4.80V V _{IN} = 5.75V _{DC} +0.5Vp-p _{AC} I _{OUT} =30mA, f=1kHz					
Current Limit	I _{LIM}		510	630	750	mA	①
Short-circuit Current	I _{SHORT}	Short V _{OUT} to V _{SS} level	-	120	210	mA	①
Thermal Shutdown Detect Temperature	T _{TSD}	Junction Temperature	-	150	-	°C	①
Thermal Shutdown Release Temperature	T _{TSR}	Junction Temperature	-	125	-	°C	①
Thermal Shutdown Hysteresis Width	T _{HYS}	T _{TSD} -T _{TSR}	-	25	-	°C	-

NOTE:

(*1) Unless otherwise stated regarding input voltage conditions, V_{IN}=V_{OUT(T)}⁽³⁾+1.0V.

(*2) V_{OUT(E)}: Effective output voltage

(i.e. the output voltage when "V_{OUT(T)}+1.0V" is provided at the V_{IN} pin while maintaining a certain I_{OUT} value.)

(*3) V_{OUT(T)}: Nominal output voltage

(*4) Characteristics of the actual V_{OUT(E)} by setting output voltage is shown in the voltage chart.

(*5) V_{dif}=V_{IN1}⁽⁷⁾-V_{OUT1}⁽⁶⁾

(*6) V_{OUT1} is a voltage equal to 98% of the output voltage whenever an amply stabilized I_{OUT} {V_{OUT(T)}+1.0V} is input

(*7) V_{IN1} is an input voltage when V_{OUT1} appears at the V_{OUT} pin while the input voltage is gradually decreased.

ELECTRICAL CHARACTERISTICS (Continued)

Voltage Chart

NOMINAL VOLTAGE (V)	E-0		E-1		E-2		NOMINAL VOLTAGE (V)	E-0		E-1		E-2	
	OUTPUT VOLTAGE (V)		DROPOUT VOLTAGE (mV)		LINE REGULATION (%/V)			OUTPUT VOLTAGE (V)		DROPOUT VOLTAGE (mV)		LINE REGULATION (%/V)	
	$V_{OUT(E)}$		V_{dif}		$\frac{\Delta V_{OUT}}{(\Delta V_{IN} \cdot V_{OUT})}$			$V_{OUT(E)}$		V_{dif}		$\frac{\Delta V_{OUT}}{(\Delta V_{IN} \cdot V_{OUT})}$	
$V_{OUT(T)}$	MIN.	MAX.	TYP.	MAX.	TYP.	MAX.	$V_{OUT(T)}$	MIN.	MAX.	TYP.	MAX.	TYP.	MAX.
1.200	1.1800	1.2200	555	660	0.1	0.25	3.150	3.1185	3.1815	190	250	0.1	0.2
1.250	1.2300	1.2700	↑	↑	↑	↑	3.200	3.1680	3.2320	170	230	↑	↑
1.300	1.2800	1.3200	↑	↑	↑	0.2	3.250	3.2175	3.2825	↑	↑	↑	↑
1.350	1.3300	1.3700	↑	↑	↑	↑	3.300	3.2670	3.3330	↑	↑	↑	↑
1.400	1.3800	1.4200	440	560	↑	↑	3.350	3.3165	3.3835	↑	↑	↑	↑
1.450	1.4300	1.4700	↑	↑	↑	↑	3.400	3.3660	3.4340	↑	↑	↑	↑
1.500	1.4800	1.5200	↑	↑	↑	↑	3.450	3.4155	3.4845	↑	↑	↑	↑
1.550	1.5300	1.5700	↑	↑	↑	↑	3.500	3.4650	3.5350	↑	↑	↑	↑
1.600	1.5800	1.6200	360	450	↑	↑	3.550	3.5145	3.5855	↑	↑	↑	↑
1.650	1.6300	1.6700	↑	↑	↑	↑	3.600	3.5640	3.6360	155	210	↑	↑
1.700	1.6800	1.7200	↑	↑	↑	↑	3.650	3.6135	3.6865	↑	↑	↑	↑
1.750	1.7300	1.7700	↑	↑	↑	↑	3.700	3.6630	3.7370	↑	↑	↑	↑
1.800	1.7800	1.8200	300	390	↑	↑	3.750	3.7125	3.7875	↑	↑	↑	↑
1.850	1.8300	1.8700	↑	↑	↑	↑	3.800	3.7620	3.8380	↑	↑	↑	↑
1.900	1.8800	1.9200	↑	↑	↑	↑	3.850	3.8115	3.8885	↑	↑	↑	↑
1.950	1.9300	1.9700	↑	↑	↑	↑	3.900	3.8610	3.9390	↑	↑	↑	↑
2.000	1.9800	2.0200	265	330	↑	↑	3.950	3.9105	3.9895	↑	↑	↑	↑
2.050	2.0295	2.0705	↑	↑	↑	↑	4.000	3.9600	4.0400	↑	↑	↑	↑
2.100	2.0790	2.1210	↑	↑	↑	↑	4.050	4.0095	4.0905	↑	↑	↑	↑
2.150	2.1285	2.1715	↑	↑	↑	↑	4.100	4.0590	4.1410	↑	↑	↑	↑
2.200	2.1780	2.2220	240	310	↑	↑	4.150	4.1085	4.1915	↑	↑	↑	↑
2.250	2.2275	2.2725	↑	↑	↑	↑	4.200	4.1580	4.2420	140	195	↑	↑
2.300	2.2770	2.3230	↑	↑	↑	↑	4.250	4.2075	4.2925	↑	↑	↑	↑
2.350	2.3265	2.3735	↑	↑	↑	↑	4.300	4.2570	4.3430	↑	↑	↑	↑
2.400	2.3760	2.4240	↑	↑	↑	↑	4.350	4.3065	4.3935	↑	↑	↑	↑
2.450	2.4255	2.4745	↑	↑	↑	↑	4.400	4.3560	4.4440	↑	↑	↑	↑
2.500	2.4750	2.5250	210	270	↑	↑	4.450	4.4055	4.4945	↑	↑	↑	↑
2.550	2.5245	2.5755	↑	↑	↑	↑	4.500	4.4550	4.5450	↑	↑	↑	↑
2.600	2.5740	2.6260	↑	↑	↑	↑	4.550	4.5045	4.5955	↑	↑	↑	↑
2.650	2.6235	2.6765	↑	↑	↑	↑	4.600	4.5540	4.6460	↑	↑	↑	↑
2.700	2.6730	2.7270	↑	↑	↑	↑	4.650	4.6035	4.6965	↑	↑	↑	↑
2.750	2.7225	2.7775	↑	↑	↑	↑	4.700	4.6530	4.7470	↑	↑	↑	↑
2.800	2.7720	2.8280	190	250	↑	↑	4.750	4.7025	4.7975	↑	↑	↑	↑
2.850	2.8215	2.8785	↑	↑	↑	↑	4.800	4.7520	4.8480	↑	↑	↑	↑
2.900	2.8710	2.9290	↑	↑	↑	↑	4.850	4.8015	4.8985	↑	↑	↑	↑
2.950	2.9205	2.9795	↑	↑	↑	↑	4.900	4.8510	4.9490	↑	↑	↑	↑
3.000	2.9700	3.0300	↑	↑	↑	↑	4.950	4.9005	4.9995	↑	↑	↑	↑
3.050	3.0195	3.0805	↑	↑	↑	↑	5.000	4.9500	5.0500	↑	↑	↑	↑
3.100	3.0690	3.1310	↑	↑	↑	↑							

OPERATIONAL EXPLANATION

The voltage divided by resistors R1 and R2 is compared with the internal reference voltage by the error amplifier. The P-channel MOSFET which is connected to the V_{OUT} pin is then driven by the subsequent output signal. The output voltage at the V_{OUT} pin is controlled and stabilized by a system of negative feedback. The current limit circuit and short circuit protection operate in relation to the level of output current and heat dissipation. Current limit circuit and short protection circuit operate with output current and thermal shutdown circuit will operate with heating. Further, the IC's internal circuitry can be shutdown via the CE pin signal.

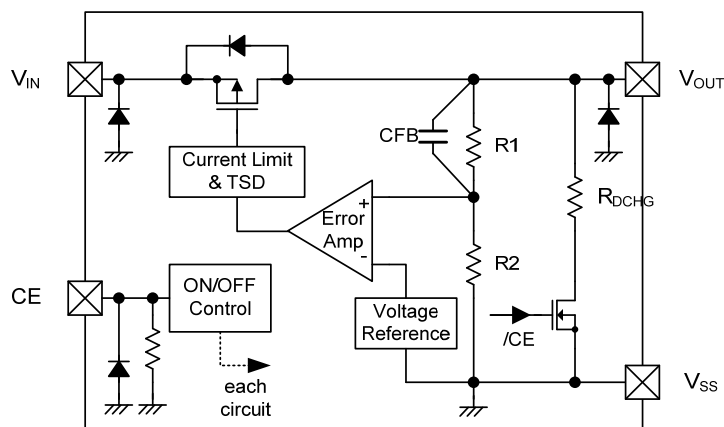

XC6503D Series

<CL Auto-Discharge Function>

XC6503D can quickly discharge the electric charge at the output capacitor (C_L), when a low signal to the CE pin, which enables a whole IC circuit put into OFF state, is inputted via the N-channel transistor located between the V_{OUT} pin and the V_{SS} pin (cf. BLOCK DIAGRAM). The C_L discharge resistance is set to 430 Ω when V_{IN} is 6.0V (TYP.) and V_{OUT} is 5.0V (TYP.). Moreover, discharge time of the output capacitor (C_L) is set by the C_L auto-discharge resistance (R_{DCHG}) and the output capacitor (C_L). By setting time constant of a C_L auto-discharge resistance value (R_{DCHG}) and an output capacitor value (C_L) as τ = C × R, the output voltage after discharge via the N-channel transistor is calculated by the following formula.

$$V = V_{OUT(E)} \times e^{-t/\tau}, \text{ or } t = \tau \ln(V_{OUT(E)} / V)$$

(V : Output voltage after discharge, V_{OUT(E)} : Initial Output voltage, t: Discharge time,
τ : C_L auto-discharge resistance R_{DCHG} × C_L Output capacitance

<Current Limiter, Short-Circuit Protection>

The protection circuit operates as a combination of an output current limiter and fold-back short circuit protection. When load current reaches the current limit level, the output voltage drops. As a result, the load current starts to reduce with showing fold-back curve. The output current finally falls at the level of 120mA when the output pin is short-circuited.

<Thermal Shutdown>

The over heat protection circuit is built-in with the XC6503 series. When the junction temperature of the IC reaches the temperature limit level (150 °C TYP.), the thermal shutdown circuit operates and the driver transistor will be turned off. The IC resumes its operation when the thermal shutdown function is released as a result of the junction temperature drops to the release point.

<CE Pin>

The IC's internal circuitry can be shutdown via the signal from the CE pin with the XC6503D series. In shutdown mode, output at the V_{OUT} pin will be pulled down to the V_{SS} level via R1, R2 and C_L auto-discharge resistance R_{DCHG}. Please note the XC6503P does not have the CE pin.

The XC6503D has a pulled down resistor at the CE pin in order to avoid an unstable operation with the CE pin open (the CE pin is left open, operation will be stopped). However, the CE pin input current will increase slightly through the pulled down resistor when operating. If the correct output voltage is applied to the CE pin, the logic is fixed and the IC will operate normally. However, if the medium voltage is input, supply current may increase as a result of an internal through current.

NOTES ON USE

- For temporary, transitional voltage drop or voltage rising phenomenon, the IC is liable to malfunction should the ratings be exceeded.
- The XC6503 series operates even if without attaching an output capacitor. However, when wiring impedance is high, operations may become unstable due to noise and/or phase lag depending on output current. Please wire the input capacitor (C_{IN}) and the output capacitor (C_L) as close to the IC as possible.
- The XC6503 installs fold-back current limit circuits. When start-up, this fold-back load curve affects its start-up characteristics. The XC6503 having output current under 2.4V may not happen to start-up with the load conditions below. In these cases, sequence control should be taken for connecting a load after the start-up execution.

Load Condition for Start-up: $I_{OUT} = V_{OUT(T)}/4.8$

$V_{OUT(T)}$: Nominal Output Voltage

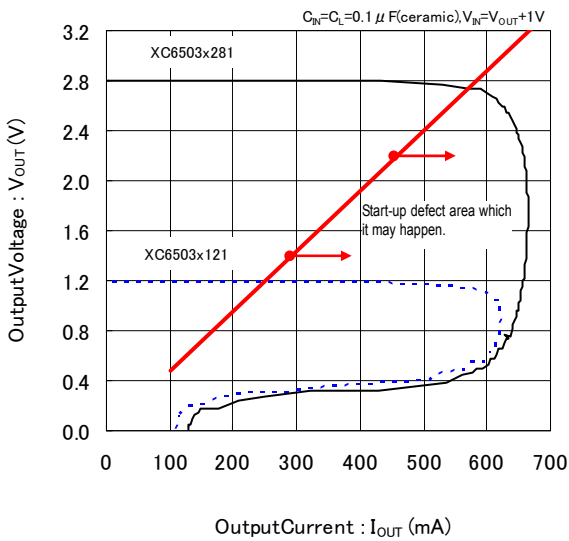

●CONDITION

NOMINAL VOLTAGE	LOAD CONDITION FOR START-UP
1.2V	250mA
1.5V	312mA
1.8V	350mA

- Torex places an importance on improving our products and its reliability. However, by any possibility, we would request user fail-safe design and post-aging treatment on system or equipment.

TEST CIRCUITS

Circuit

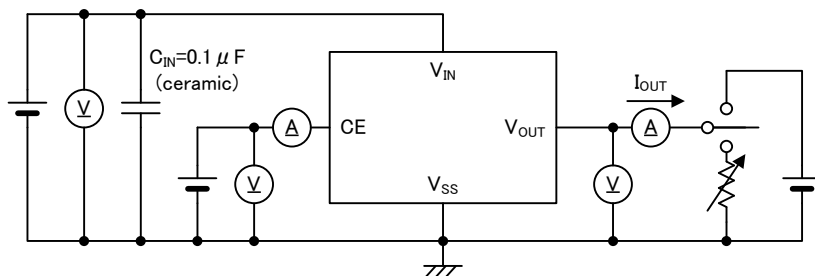

Circuit

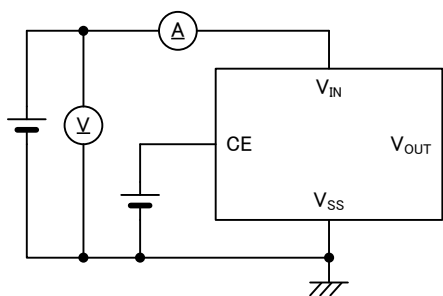

Circuit

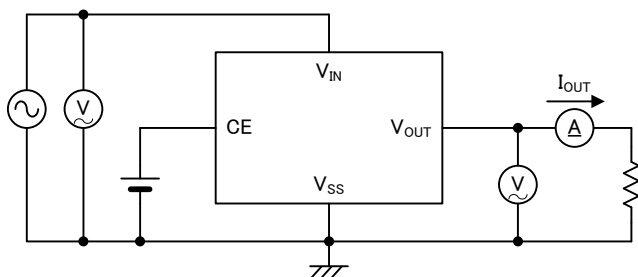

* For the XC6503P series, CE pin is connected to the V_{IN} internally.

TYPICAL PERFORMANCE CHARACTERISTICS

(1) OutputVoltage v.s. OutputCurrent

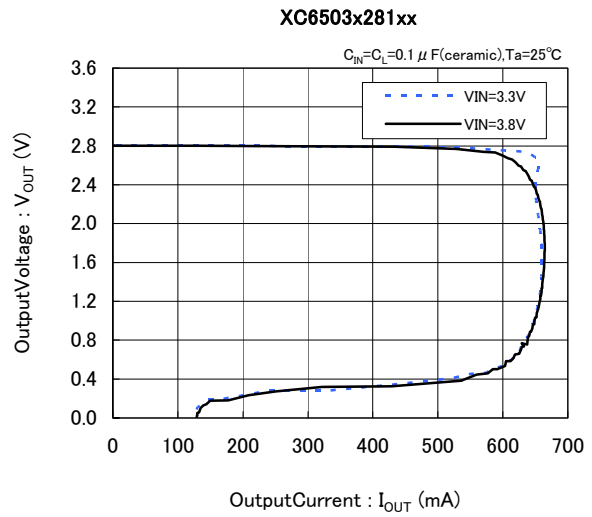
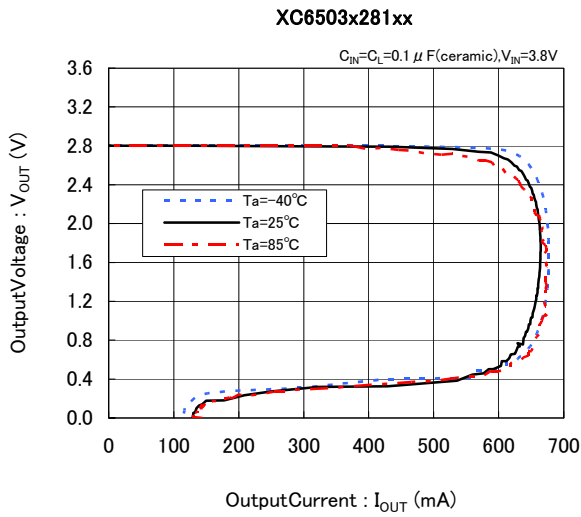
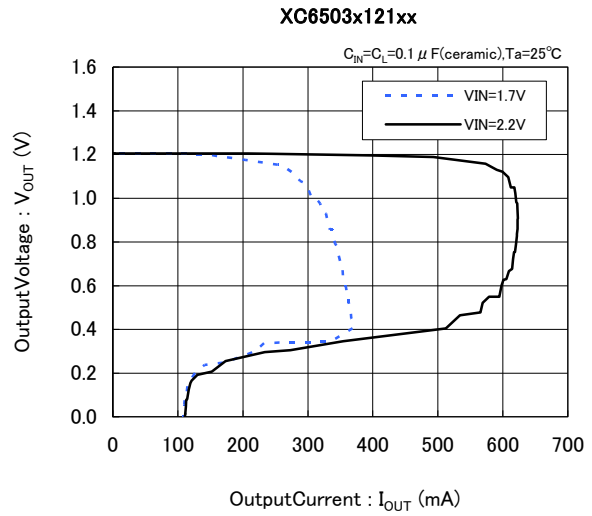
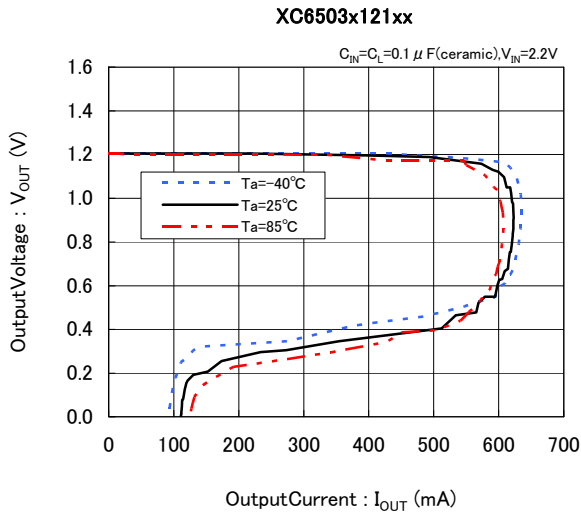

(2) OutputVoltage v.s. InputVoltage

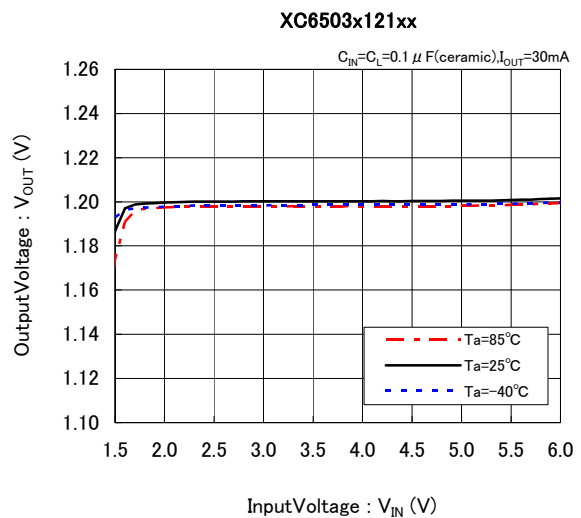
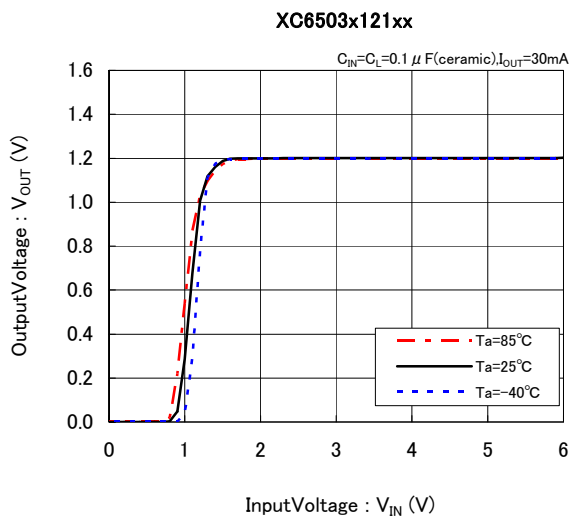

TYPICAL PERFORMANCE CHARACTERISTICS (Continued)

(2) OutputVoltage v.s. InputVoltage

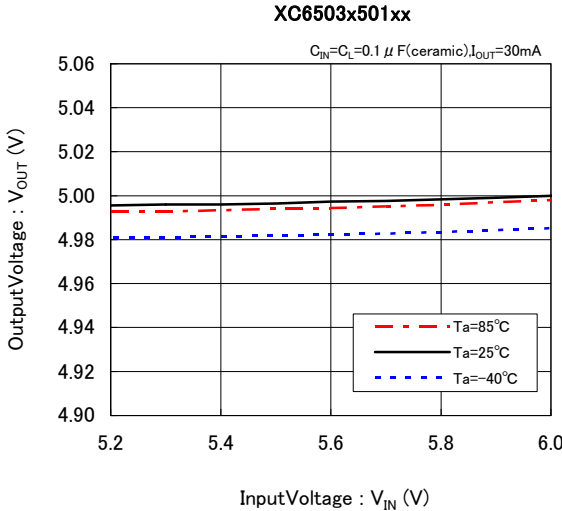
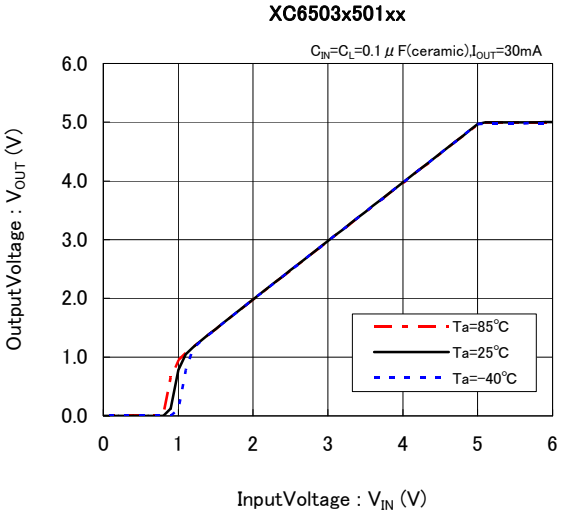
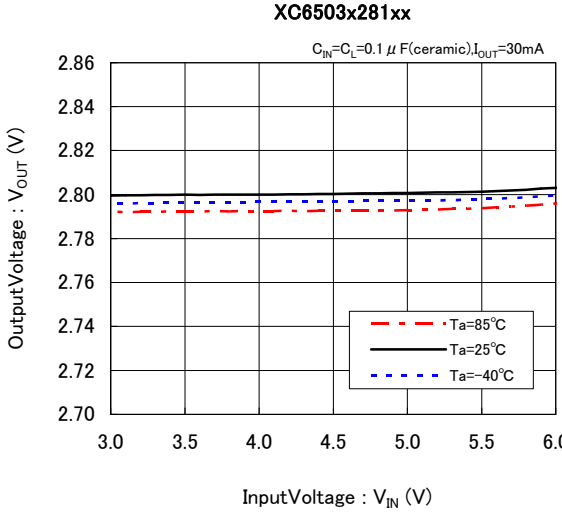
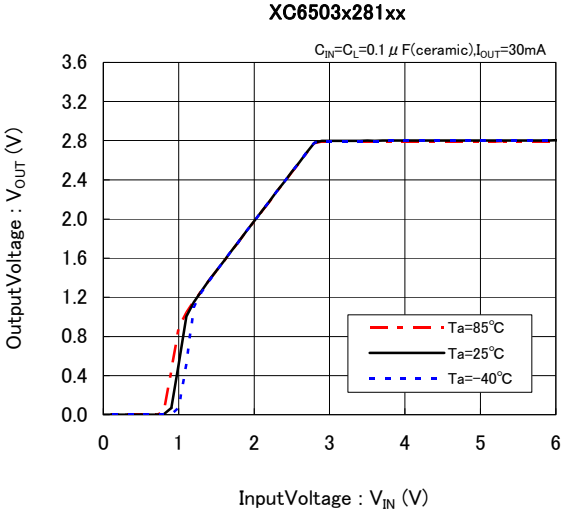

(3) DropoutVoltage v.s. OutputCurrent

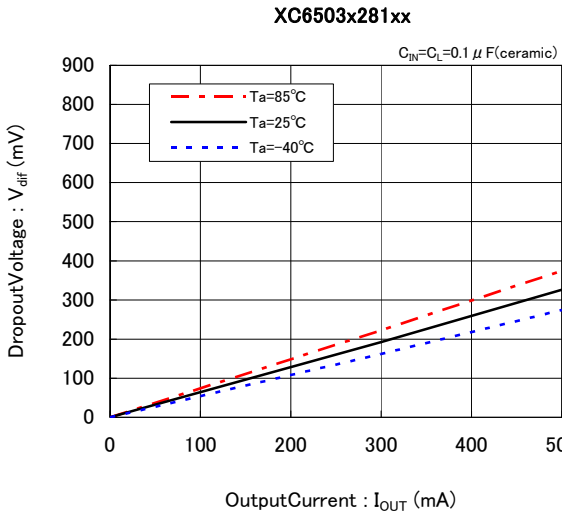
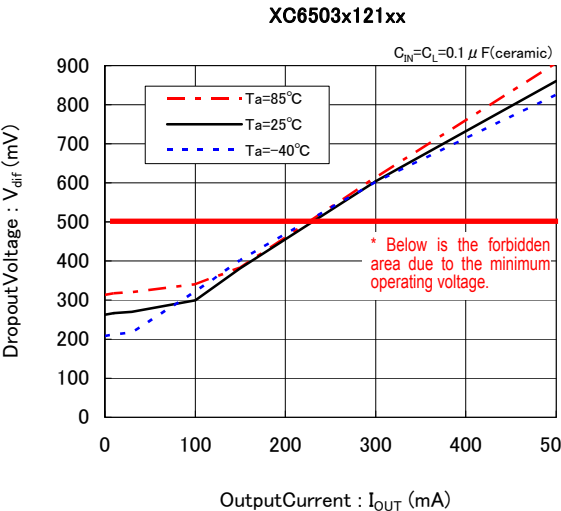

TYPICAL PERFORMANCE CHARACTERISTICS (Continued)

(3) Dropout Voltage v.s. Output Current

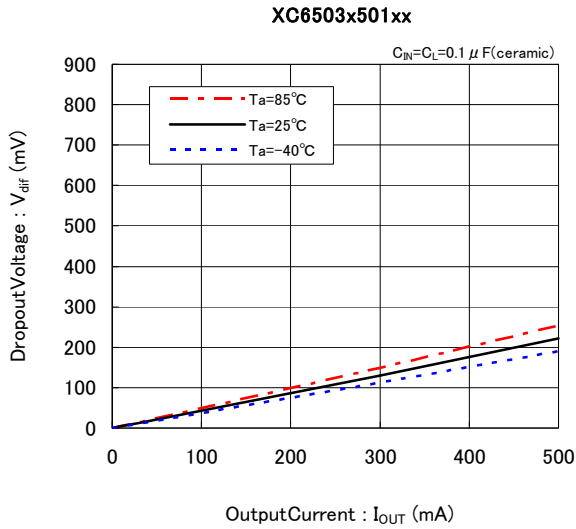

(4) Supply Current v.s. Input Voltage

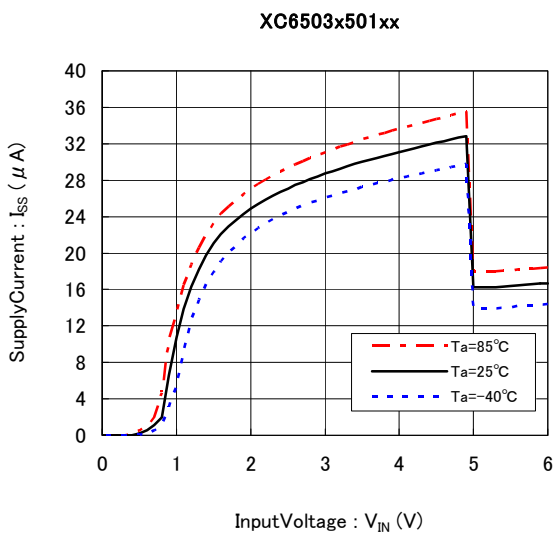
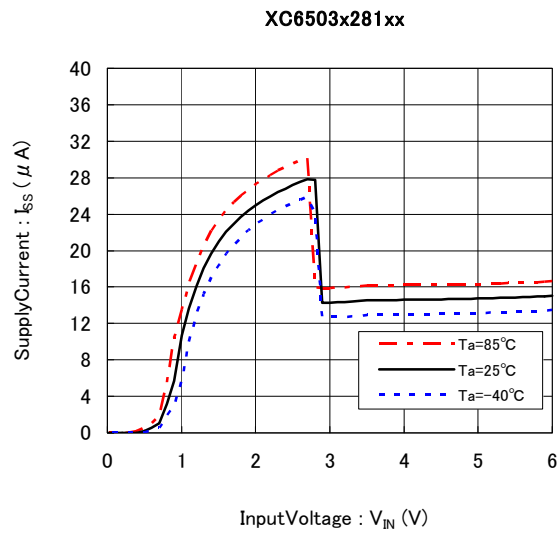
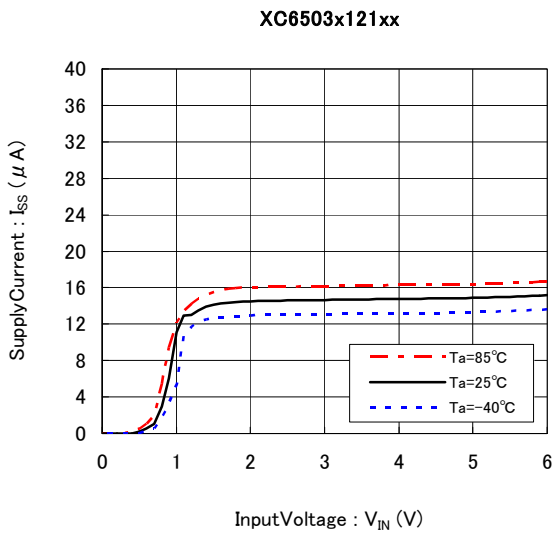

TYPICAL PERFORMANCE CHARACTERISTICS (Continued)

(5) OutputVoltage v.s. AmbientTemperature

XC6503x121xx

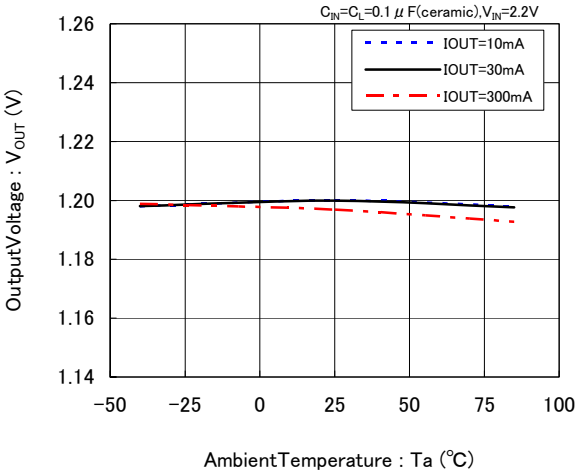

XC6503x281xx

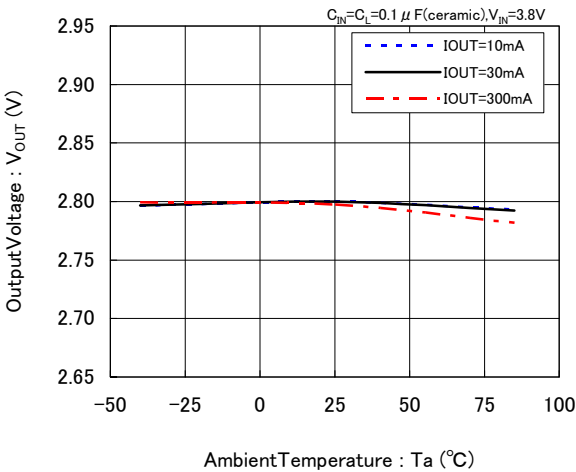

XC6503x501xx

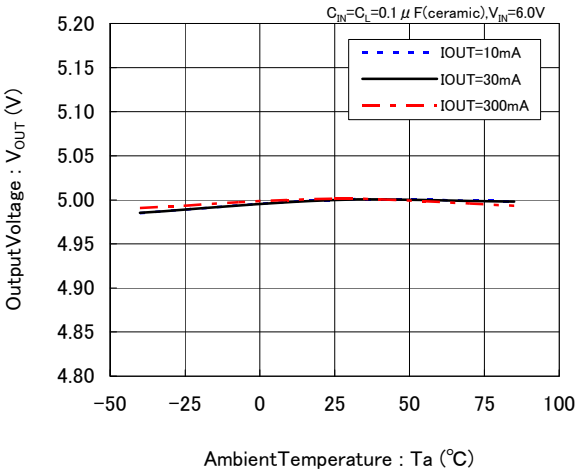

(6) Rising Response Time

XC6503x121xx

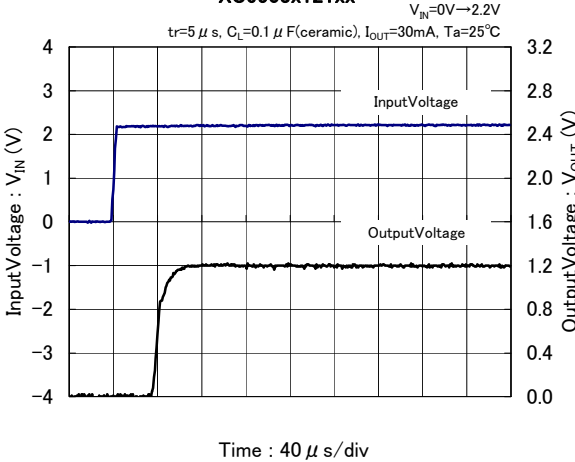

XC6503x281xx

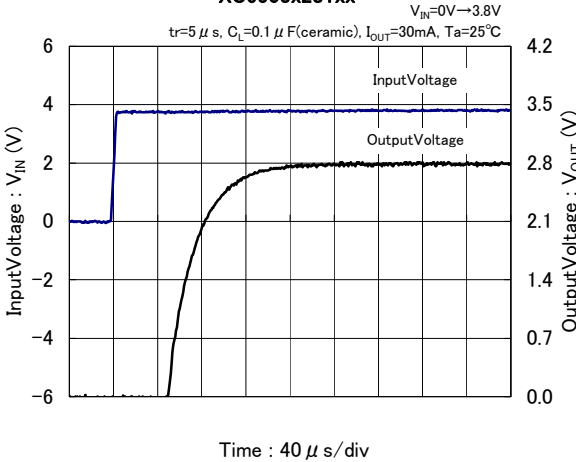

TYPICAL PERFORMANCE CHARACTERISTICS (Continued)

(6) Rising Respose Time

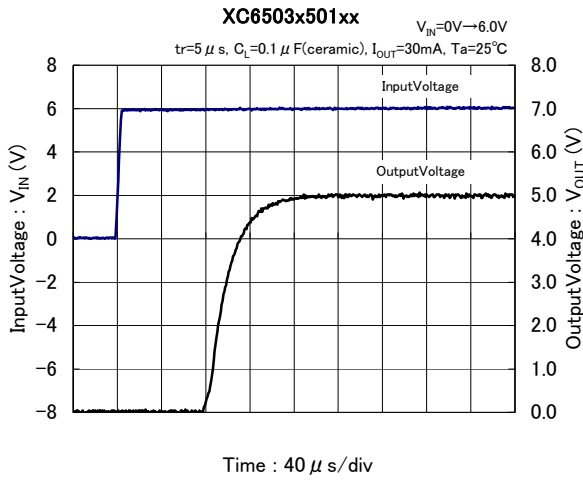

(7) Rush Current

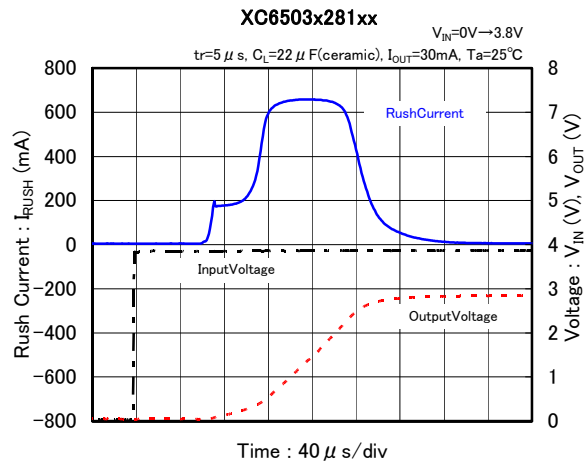
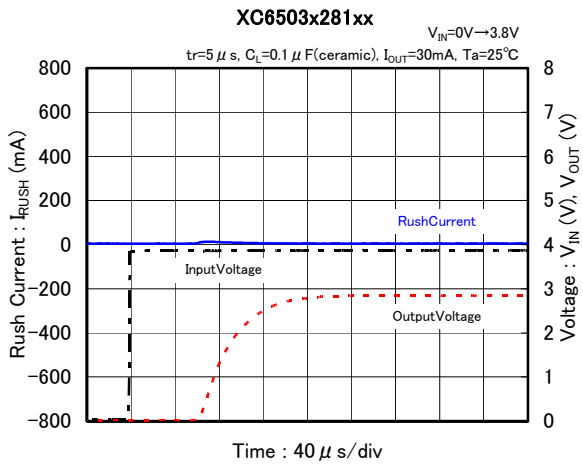

(8) CE Rising Respose Time

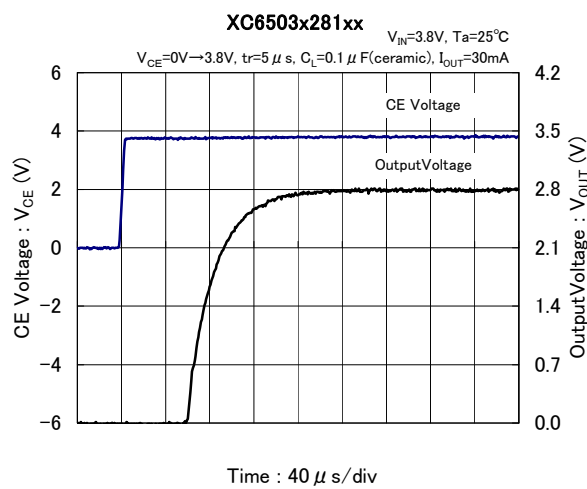
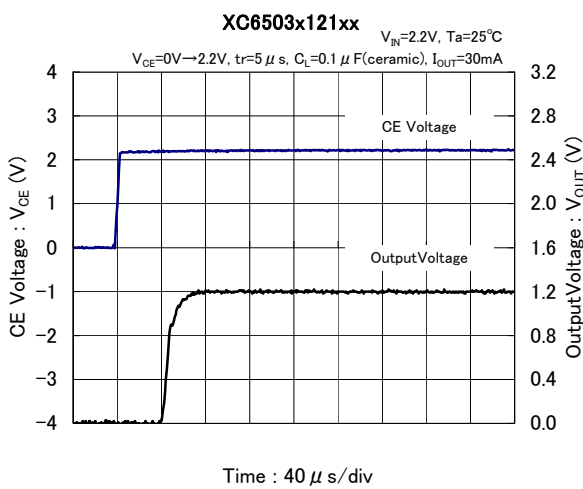

TYPICAL PERFORMANCE CHARACTERISTICS (Continued)

(8) CE Rising Respose Time

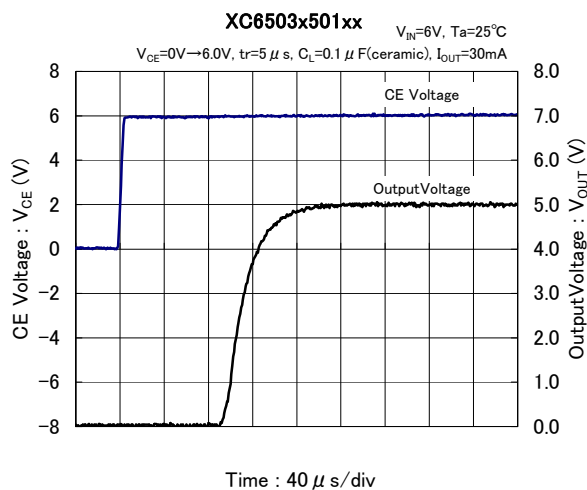

(9) Line transient response

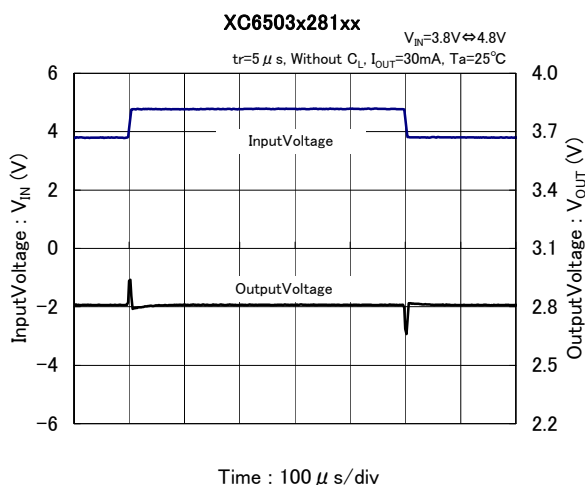
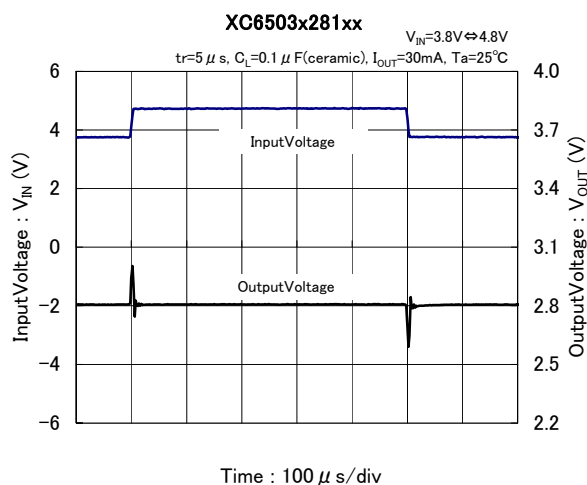
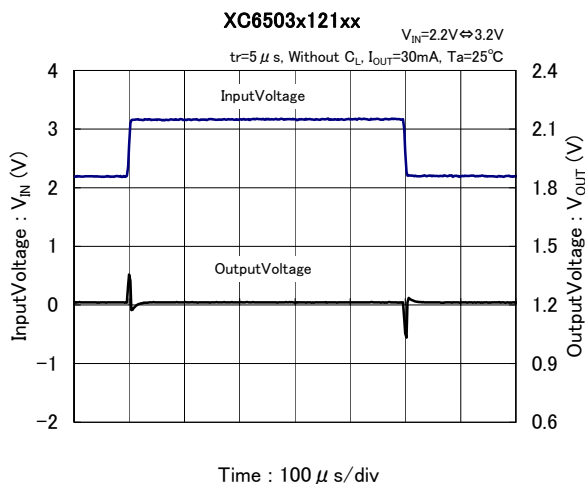
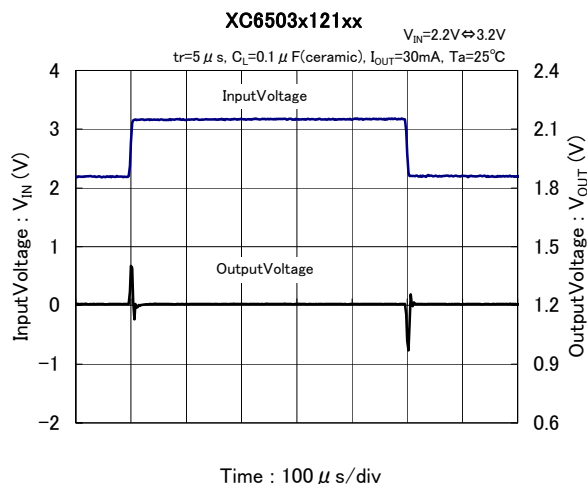

TYPICAL PERFORMANCE CHARACTERISTICS (Continued)

(9) Line transient response

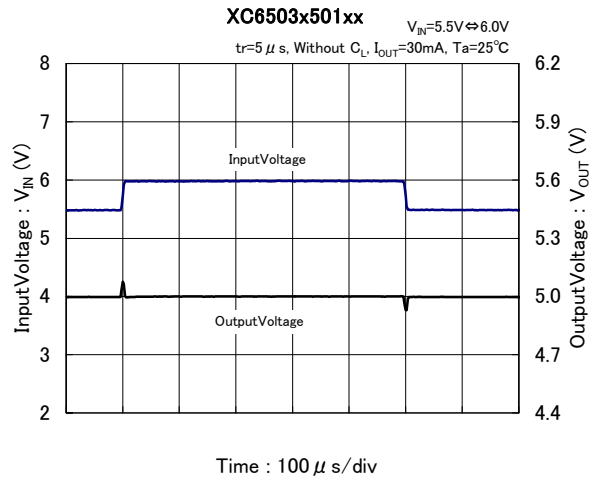
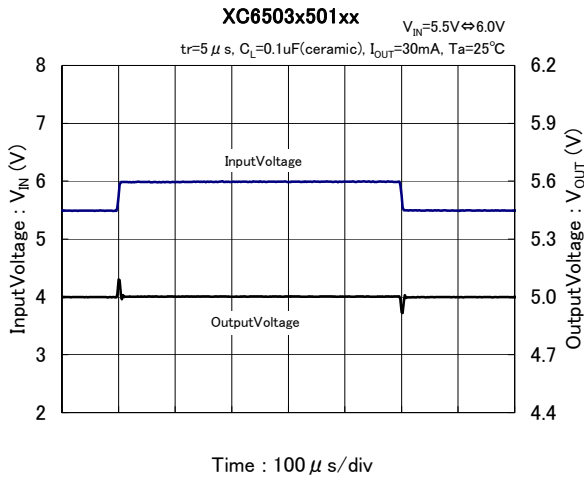

(10) Load transient response

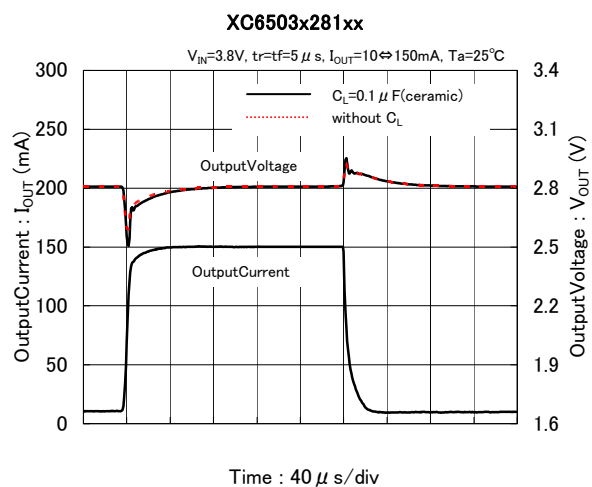
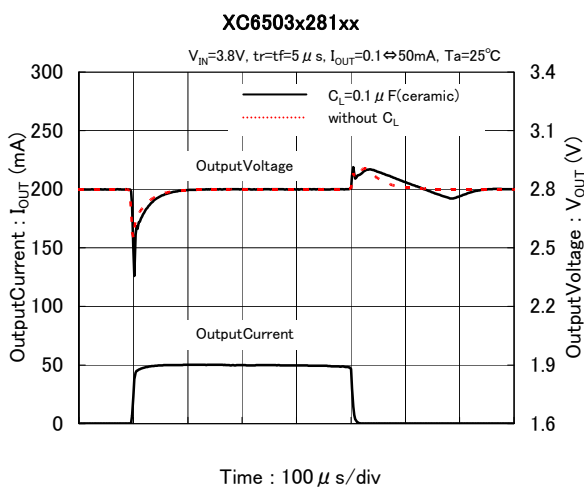
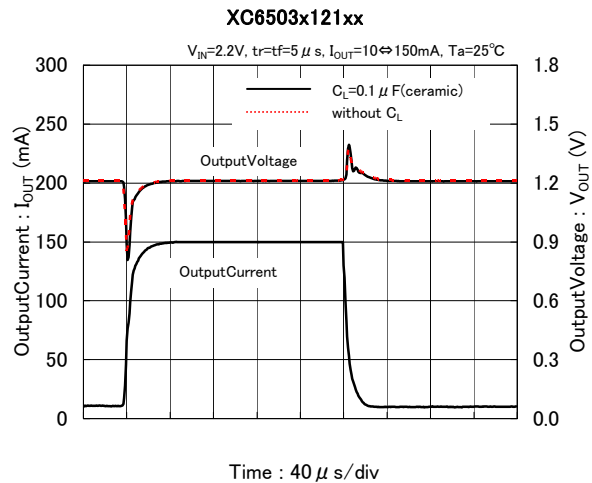
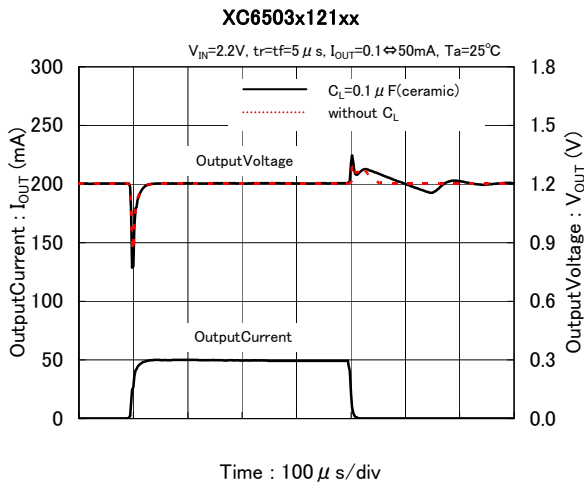

TYPICAL PERFORMANCE CHARACTERISTICS (Continued)

(10) Load transient response

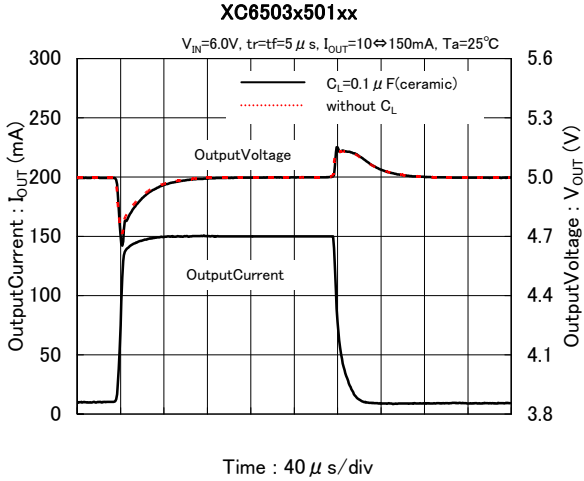
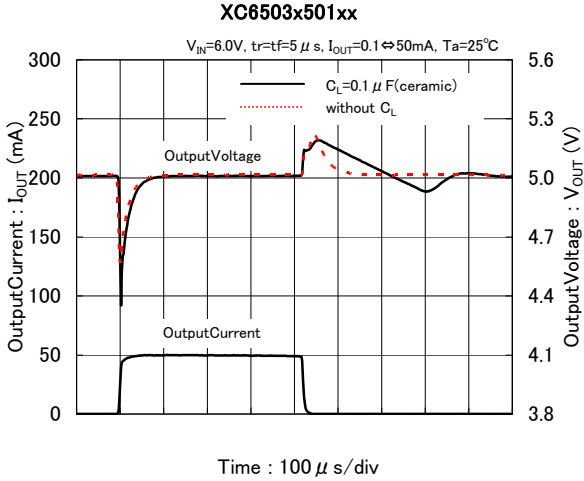

(11) Ripple Rejection Ratio

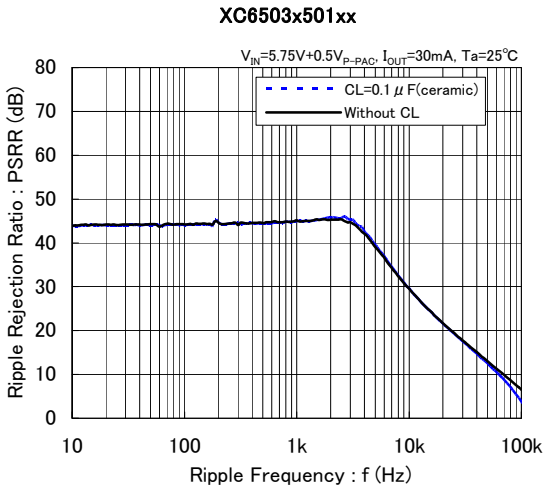
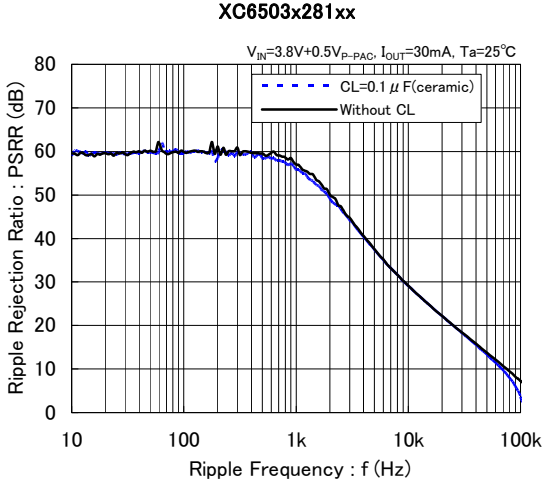
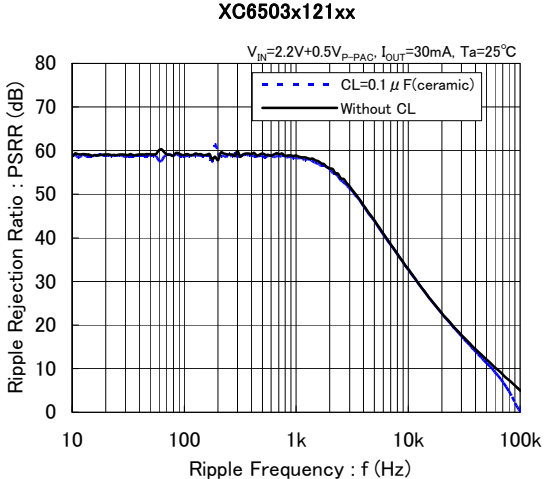

PACKAGING INFORMATION (Continued)

USP-4 Reference Pattern Layout

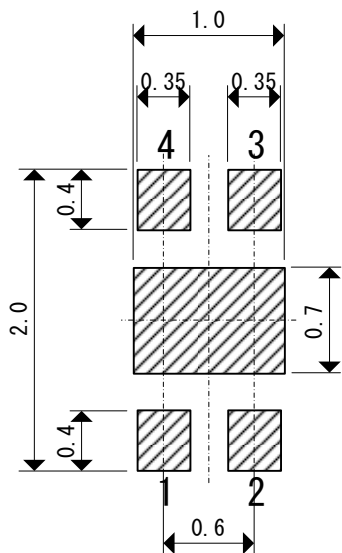

USP-4 Reference Metal Mask Design

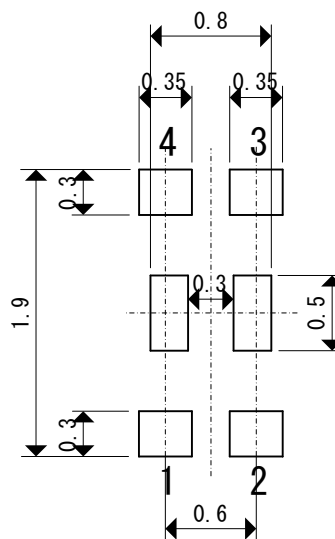

PACKAGING INFORMATION (Continued)

USP-4 Power Dissipation

Power dissipation data for the USP-4 is shown in this page.

The value of power dissipation varies with the mount board conditions.

Please use this data as one of reference data taken in the described condition.

1. Measurement Condition (Reference data)

- Condition: Mount on a board
- Ambient: Natural convection
- Soldering: Lead (Pb) free
- Board:
 - Dimensions 40 x 40 mm (1600 mm² in one side)
 - Copper (Cu) traces occupy 50% of the board area
 - In top and back faces
 - Package heat-sink is tied to the copper traces
- Material: Glass Epoxy (FR-4)
- Thickness: 1.6 mm
- Through-hole: 4 x 0.8 Diameter

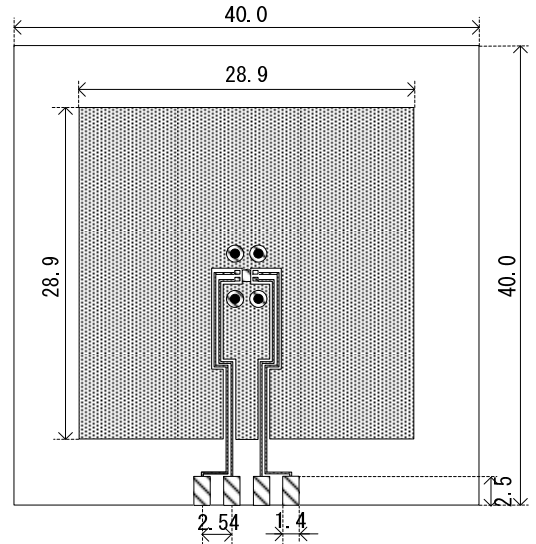

Evaluation Board (Unit: mm)

2. Power Dissipation vs. Ambient temperature

Board Mount ($T_j \text{ max} = 125$)

Ambient Temperature (°C)	Power Dissipation Pd (mW)	Thermal Resistance (°C/W)
25	1000	100.00
85	400	

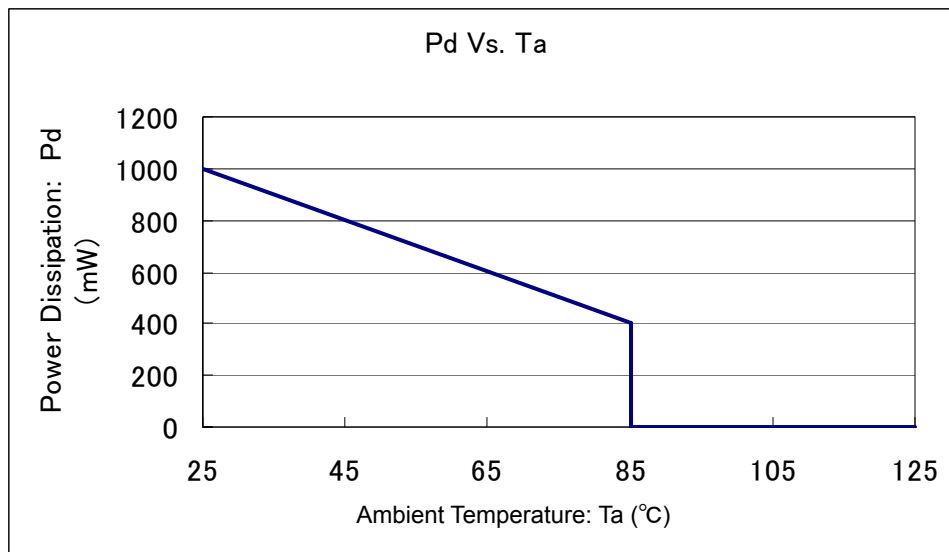

PACKAGING INFORMATION (Continued)

SOT-25 Power Dissipation

Power dissipation data for the SOT-25 is shown in this page.

The value of power dissipation varies with the mount board conditions.

Please use this data as one of reference data taken in the described condition.

1. Measurement Condition (Reference data)

Condition:	Mount on a board
Ambient:	Natural convection
Soldering:	Lead (Pb) free
Board:	Dimensions 40 x 40 mm (1600 mm ² in one side) Copper (Cu) traces occupy 50% of the board area In top and back faces Package heat-sink is tied to the copper traces (Board of SOT-26 is used.)
Material:	Glass Epoxy (FR-4)
Thickness:	1.6 mm
Through-hole:	4 x 0.8 Diameter

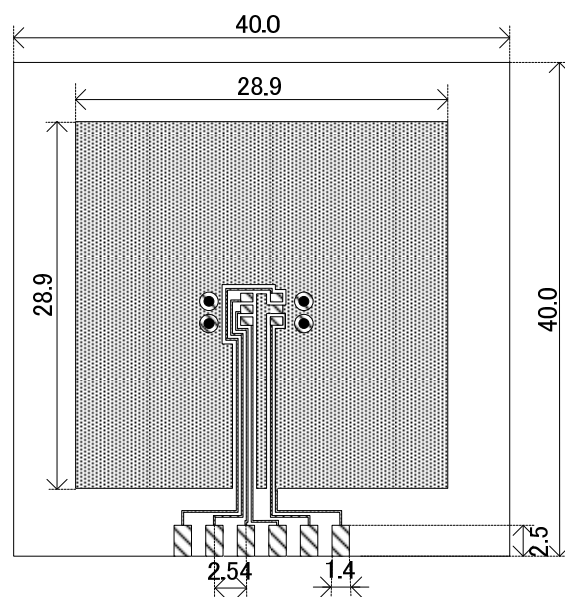

Evaluation Board (Unit: mm)

2. Power Dissipation vs. Ambient temperature

Board Mount ($T_j \text{ max} = 125$)

Ambient Temperature (°C)	Power Dissipation Pd (mW)	Thermal Resistance (°C/W)
25	600	166.67
85	240	

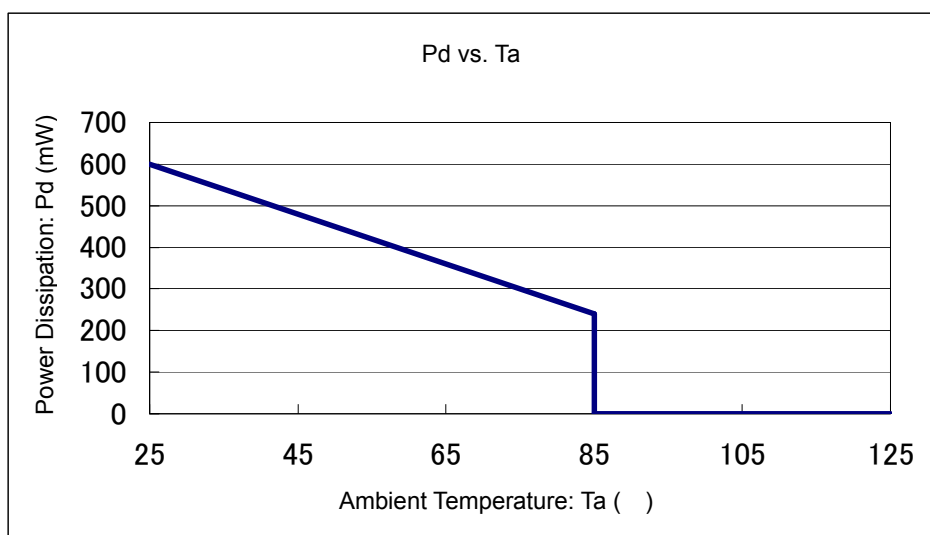

PACKAGING INFORMATION (Continued)

SOT-89-5 Power Dissipation

Power dissipation data for the SOT-89-5 is shown in this page.
 The value of power dissipation varies with the mount board conditions.
 Please use this data as one of reference data taken in the described condition.

1. Measurement Condition (Reference data)

- Condition: Mount on a board
- Ambient: Natural convection
- Soldering: Lead (Pb) free
- Board: Dimensions 40 x 40 mm (1600 mm² in one side)
 Copper (Cu) traces occupy 50% of the board area
 In top and back faces
 Package heat-sink is tied to the copper traces
- Material: Glass Epoxy (FR-4)
- Thickness: 1.6 mm
- Through-hole: 5 x 0.8 Diameter

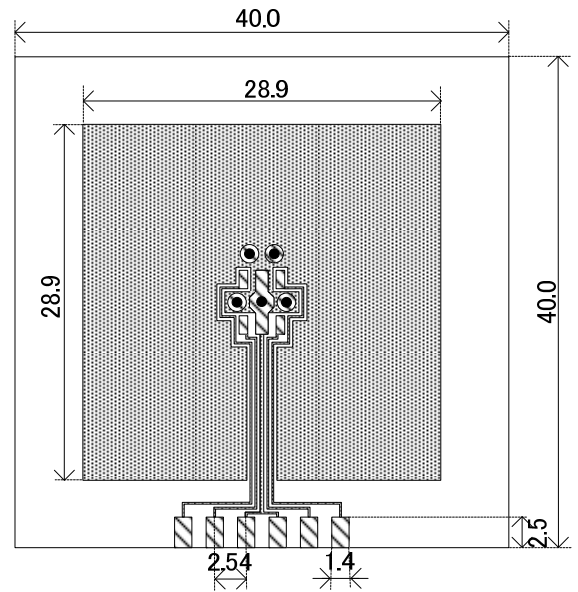

Evaluation Board (Unit: mm)

2. Power Dissipation vs. Ambient temperature

Board Mount ($T_j \text{ max} = 125$)

Ambient Temperature (°C)	Power Dissipation Pd (mW)	Thermal Resistance (°C/W)
25	1300	76.92
85	520	

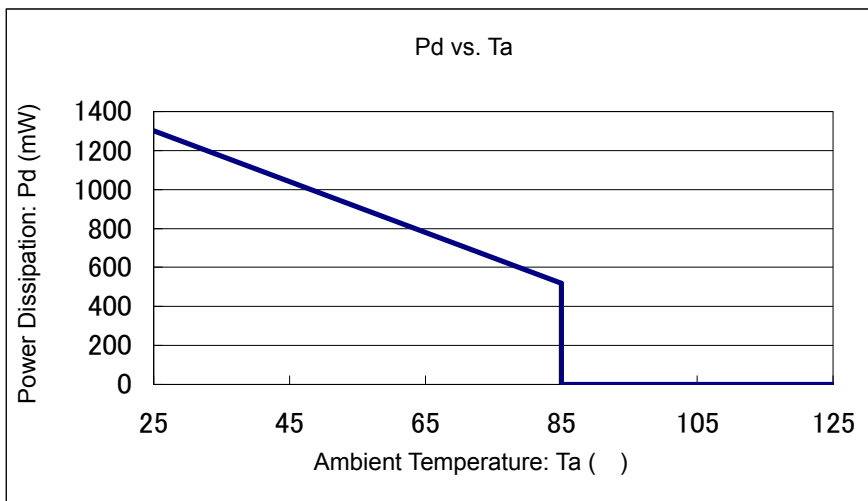

PACKAGING INFORMATION (Continued)

TO-252 Power Dissipation

Power dissipation data for the TO-252 is shown in this page.
The value of power dissipation varies with the mount board conditions.
Please use this data as one of reference data taken in the described condition.

1. Measurement Condition (Reference data)

- Condition: Mount on a board
- Ambient: Natural convection
- Soldering: Lead (Pb) free
- Board: Dimensions 40 x 40 mm (1600 mm² in one side)
Copper (Cu) traces occupy 50% of the board area
In top and back faces
Package heat-sink is tied to the copper traces
- Material: Glass Epoxy (FR-4)
- Thickness: 1.6 mm
- Through-hole: 4 x 0.8 Diameter

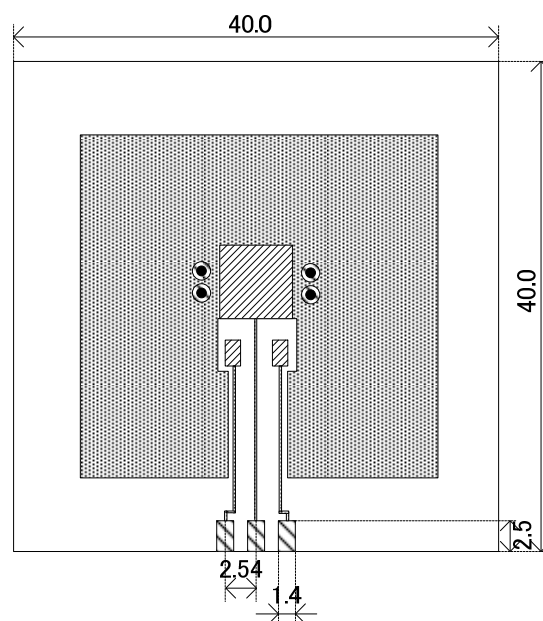

Evaluation Board (Unit: mm)

2. Power Dissipation vs. Ambient temperature

Board Mount ($T_j \text{ max} = 125$)

Ambient Temperature (°C)	Power Dissipation Pd (mW)	Thermal Resistance (°C/W)
25	1800	55.56
85	720	

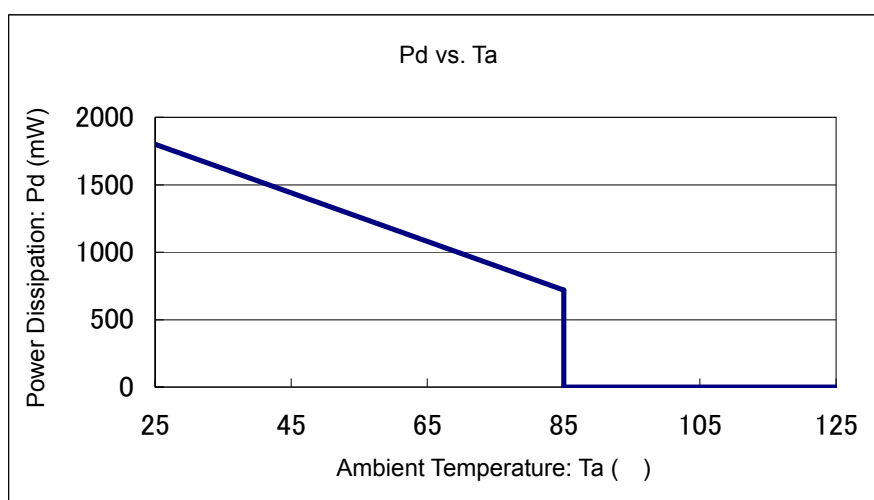

MARKING RULE

SOT-25, SOT-89-5, USP-4, TO-252

represents product series.

MARK	PRODUCT SERIES
1 ^(*)	XC6503******

(*) Dot mark is printed under MARK ① (refer to drawings below).

represents type of regulators for standard product.

MARK				PRODUCT SERIES	PACKAGE
OUTPUT VOLTAGE 0.1V INCREMENTS		OUTPUT VOLTAGE 0.05V INCREMENTS			
VOLTAGE= 1.2 ~ 4.1V	VOLTAGE= 4.2 ~ 5.0V	VOLTAGE= 1.25 ~ 4.15V	VOLTAGE= 4.25 ~ 4.95V		
0	1	2	3	XC6503A****-G	SOT-25, SOT-89-5, USP-4
				XC6503P****-G	TO-252
4	5	6	7	XC6503B****-G	SOT-25, SOT-89-5, USP-4
8	9	A	B	XC6503C****-G	SOT-25, SOT-89-5, USP-4
C	D	E	F	XC6503D****-G	SOT-25, SOT-89-5, USP-4

represents output voltage.

MARK	OUTPUT VOLTAGE (V)				MARK	OUTPUT VOLTAGE (V)			
0	1.20	4.20	1.25	4.25	F	2.70	-	2.75	-
1	1.30	4.30	1.35	4.35	H	2.80	-	2.85	-
2	1.40	4.40	1.45	4.45	K	2.90	-	2.95	-
3	1.50	4.50	1.55	4.55	L	3.00	-	3.05	-
4	1.60	4.60	1.65	4.65	M	3.10	-	3.15	-
5	1.70	4.70	1.75	4.75	N	3.20	-	3.25	-
6	1.80	4.80	1.85	4.85	P	3.30	-	3.35	-
7	1.90	4.90	1.95	4.95	R	3.40	-	3.45	-
8	2.00	5.00	2.05	-	S	3.50	-	3.55	-
9	2.10	-	2.15	-	T	3.60	-	3.65	-
A	2.20	-	2.25	-	U	3.70	-	3.75	-
B	2.30	-	2.35	-	V	3.80	-	3.85	-
C	2.40	-	2.45	-	X	3.90	-	3.95	-
D	2.50	-	2.55	-	Y	4.00	-	4.05	-
E	2.60	-	2.65	-	Z	4.10	-	4.15	-

* USP-4 and TO-252 are under development.

MARKING RULE (Continued)

represents production lot number

01 to 09, 0A to 0Z, 11 to 9Z, A1 to A9, AA to Z9, ZA to ZZ repeated. (G, I, J, O, Q, W excluded)

* No character inversion used.

SOT-25

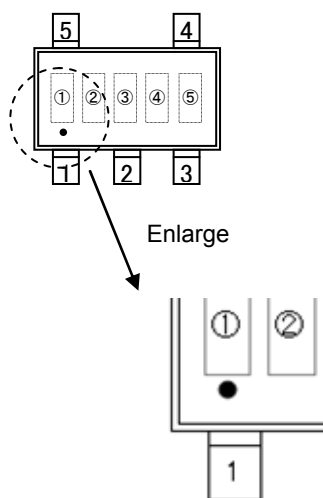

SOT-89-5

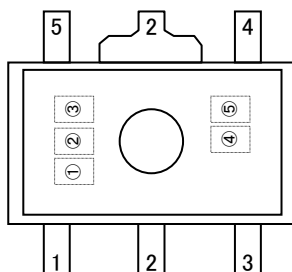

USP-4

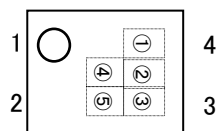

TO-252

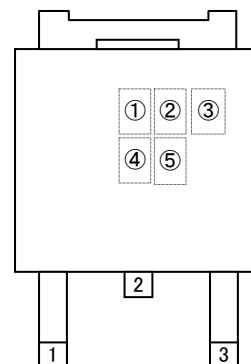

* USP-4 and TO-252 are under development.

1. The products and product specifications contained herein are subject to change without notice to improve performance characteristics. Consult us, or our representatives before use, to confirm that the information in this datasheet is up to date.
2. We assume no responsibility for any infringement of patents, patent rights, or other rights arising from the use of any information and circuitry in this datasheet.
3. Please ensure suitable shipping controls (including fail-safe designs and aging protection) are in force for equipment employing products listed in this datasheet.
4. The products in this datasheet are not developed, designed, or approved for use with such equipment whose failure of malfunction can be reasonably expected to directly endanger the life of, or cause significant injury to, the user.
(e.g. Atomic energy; aerospace; transport; combustion and associated safety equipment thereof.)
5. Please use the products listed in this datasheet within the specified ranges.
Should you wish to use the products under conditions exceeding the specifications, please consult us or our representatives.
6. We assume no responsibility for damage or loss due to abnormal use.
7. All rights reserved. No part of this datasheet may be copied or reproduced without the prior permission of TOREX SEMICONDUCTOR LTD.

TOREX SEMICONDUCTOR LTD.